

PHASER® 850  
COLOR PRINTER

ADVANCED FEATURES  
AND TROUBLESHOOTING MANUAL





**Phaser® 850 Color Printer  
Advanced Features and Troubleshooting Manual**

Copyright © Tektronix, Inc. Unpublished rights reserved under the copyright laws of the United States. Contents of this publication may not be reproduced in any form without permission of Tektronix, Inc.

Tektronix<sup>®</sup>, Phaser<sup>®</sup>, PhaserShare<sup>®</sup>, ColorStix<sup>®</sup>, the TekColor<sup>®</sup> icon, and Made For Each Other<sup>®</sup> are registered trademarks of Tektronix, Inc. PhaserLink<sup>™</sup>, PhaserPort<sup>™</sup>, PhaserPrint<sup>™</sup>, PhaserSym<sup>™</sup>, PhaserTools<sup>™</sup>, TekSMART<sup>™</sup>, and the TekColor<sup>™</sup> name are trademarks of Tektronix, Inc. TekColor Care<sup>SM</sup> and RealSUPPORT<sup>SM</sup> are service marks of Tektronix, Inc.

Adobe<sup>®</sup>, Acrobat<sup>®</sup>, Acrobat<sup>®</sup> Reader, Illustrator<sup>®</sup>, PageMaker<sup>®</sup>, Photoshop<sup>®</sup>, and PostScript<sup>®</sup>, ATM<sup>®</sup>, Adobe Garamond<sup>®</sup>, Birch<sup>®</sup>, Carta<sup>®</sup>, Mythos<sup>®</sup>, Quake<sup>®</sup>, and Tekton<sup>®</sup> are registered trademarks and Adobe Jenson<sup>™</sup>, Adobe Brilliant Screens<sup>™</sup> technology, and IntelliSelect<sup>™</sup> are trademarks of Adobe Systems Incorporated or its subsidiaries which may be registered in certain jurisdictions.

Apple<sup>®</sup>, LaserWriter<sup>®</sup>, LocalTalk<sup>®</sup>, Macintosh<sup>®</sup>, Mac<sup>®</sup> OS, AppleTalk<sup>®</sup>, TrueType2<sup>®</sup>, Apple Chancery<sup>®</sup>, Chicago<sup>®</sup>, Geneva<sup>®</sup>, Monaco<sup>®</sup>, and New York<sup>®</sup> are registered trademarks, and QuickDraw<sup>™</sup> is a trademark of Apple Computer Incorporated.

Marigold<sup>™</sup> and Oxford<sup>™</sup> are trademarks of AlphaOmega Typography.

FTP<sup>®</sup> Software is a registered trademark of FTP Software, Incorporated.

PCL<sup>®</sup> and HP-GL<sup>®</sup> are registered trademarks of Hewlett-Packard Corporation.

Hoefler Text was designed by the Hoefler Type Foundry.

ITC Avant Guard Gothic<sup>®</sup>, ITC Bookman<sup>®</sup>, ITC Lubalin Graph<sup>®</sup>, ITC Mona Lisa<sup>®</sup>, ITC Symbol<sup>®</sup>, ITC Zapf Chancery<sup>®</sup>, and ITC Zapf Dingbats<sup>®</sup> are registered trademarks of International Typeface Corporation.

Bernhard Modern<sup>™</sup>, Clarendon<sup>™</sup>, Coronet<sup>™</sup>, Helvetica<sup>™</sup>, New Century Schoolbook<sup>™</sup>, Optima<sup>™</sup>, Palatino<sup>™</sup>, Stempel Garamond<sup>™</sup>, Times<sup>™</sup>, and Univers<sup>™</sup> are trademarks of Linotype-Hell AG and/or its subsidiaries.

MS-DOS<sup>®</sup> and Windows<sup>®</sup> are registered trademarks of Microsoft Corporation.

Wingdings<sup>™</sup> in TrueType<sup>®</sup> format is a product of Microsoft Corporation. WingDings is a trademark of Microsoft Corporation and TrueType is a registered trademark of Apple Computer, Inc.

Albertus<sup>™</sup>, Arial<sup>™</sup>, Gill Sans<sup>™</sup>, Joanna<sup>™</sup>, and Times New Roman<sup>™</sup> are trademarks of Monotype Corporation.

Antique Olive<sup>®</sup> is a registered trademark of M. Olive.

Eurostile<sup>™</sup> is a trademark of Nebiolo.

Novell<sup>®</sup> and NetWare<sup>®</sup> are registered trademarks of Novell, Incorporated.

Sun<sup>®</sup>, Sun Microsystems<sup>®</sup>, and Sun Microsystems Computer Corporation<sup>®</sup> are registered trademarks of Sun Microsystems, Incorporated. SPARC<sup>®</sup> is a registered trademark of SPARC International, Incorporated. SPARCstation<sup>™</sup> is a trademark of SPARC International, Incorporated, licensed exclusively to Sun Microsystems, Incorporated.

Ethernet<sup>®</sup> is a registered trademark of Xerox Corporation.

UNIX<sup>®</sup> is a registered trademark in the US and other countries, licensed exclusively through X/Open Company Limited.

Other marks are trademarks or registered trademarks of the companies with which they are associated.

PANTONE<sup>®</sup> Colors generated by the Phaser 850 Color Printer are four- and/or three-color process simulations and may not match PANTONE-identified solid color standards. Use current PANTONE Color Reference Manuals for accurate colors.

PANTONE Color simulations are only obtainable on this product when driven by qualified Pantone-licensed software packages. Contact Pantone, Inc. for a current list of qualified licensees. All trademarks noted herein are either the property of Tektronix, Inc., Pantone, Inc., or their respective companies.

© Pantone, Inc., 1988.

# User safety summary

## Terms in manual:

**Caution:** Conditions that can result in damage to the product.

**Warning:** Conditions that can result in personal injury or loss of life.

**Use proper power source:** Do not operate this product from a power source that applies more than the voltage specified. To avoid fire hazard, use only the power cord specified for this product. In hospital applications, grounding reliability can only be achieved by the use of a hospital grade power cord, and the equipment is connected to an equivalent receptacle marked “hospital only” or “hospital grade.”

**Operation of product:** There are no user-serviceable parts inside the product. Avoid electric shock by contacting a qualified service technician to repair the product. Do not operate without the covers and panels properly installed. Do not operate in an atmosphere of explosive gases or flammable mixtures.

**Safety instructions:** Read all installation instructions carefully before you plug the product into a power source.

## Terms on product:

**CAUTION:** A personal injury hazard exists that may not be apparent. For example, a panel may cover the hazardous area. Also applies to a hazard to property including the product itself.

**DANGER:** A personal injury hazard exists in the area where you see the sign.

**Care of product:** Disconnect the power plug by pulling the plug, not the cord. Disconnect the power plug if the power cord or plug is frayed or otherwise damaged, if you spill anything into the case, if product is exposed to any excess moisture, if product is dropped or damaged, if you suspect that the product needs servicing or repair, and whenever you clean the product.

**Ground the product:** Plug the three-wire power cord (with grounding prong) into grounded AC outlets only. For protection against electric shock, this product is classified Class I, and Type B where applicable.

## Symbols as marked on product:

DANGER high voltage:



Protective ground (earth) terminal:



Hot surface on or in the printer. Use caution to avoid personal injury:



Use caution. Refer to the manual(s) for information:



**Warning**

If the product loses the ground connection, usage of knobs and controls (and other conductive parts) can cause an electrical shock. Electrical product may be hazardous if misused.

**Warning**

For your protection, do not defeat any interlocks.

# Contents

User safety summary 3

## Printer Management

PhaserLink Printer Management software 1

Job Accounting 1

Usage Profile 2

## Fonts

Resident typefaces (PostScript) 3

Resident typefaces (PCL5C) 3

Downloading fonts 4

Printing a list of resident fonts 6

## Image Smoothing

## Quick Collate

## Separation Pages

## PANTONE Colors

Methods of printing PANTONE Colors 10

Installing the PANTONE Color files 11

Printing the PANTONE Color Chart 12

## PhaserPrint Plug-in for Photoshop

Installing the plug-in: Macintosh 14

Installing the plug-in: Windows 15

Using the plug-in 16

Selecting options in the PhaserPrint dialog box 17

## Printer Utilities

Locating the files on the printer's CD-ROM 24

Locating files on the Tektronix World Wide Web site 25

Locating files on the Tektronix FTP server 26

Downloading files to the printer from a Macintosh 27

Downloading files to the printer from a PC 29

## Advanced Printing Features for Phaser 850 Printers

Previewing with 1st Page Preview 32

Automatic tray switching 34

Front Panel Intensity 34

Intelligent Ready mode 34

## Color Sampler Charts for Phaser 850 Printers

Overview 35

Color charts 36

Printing a color sampler chart from the Phaser 850 printer's front panel 37

Printing the color sampler charts with utility files 38

## Troubleshooting Phaser 850 Printers

Useful tools 39

Front panel messages 41

Problems with automatic two-sided printing 45

Problems printing on labels 46

Print Quality Problems 47

Printing problems 49

Preventing media jams 50

Turning the Startup Page on or off 51

Protected mode for the front panel menu 52

Turning Sys/Start Job execution on or off 53

## Cleaning Phaser 850 Printers

Selecting the source for cleaning pages 54

Cleaning supplies 54

Light stripes on prints 55

Cleaning for oily streaks 58

Cleaning for ink smears: internal paper path 59

Cleaning for ink smears: paper-feed rollers 61

Cleaning for ink smears: paper-exit path 65

Cleaning for media tray jams 68

Cleaning for lower tray jams: paper-feed rollers 72

## Regulatory Information for Phaser 850 Printers

Canadian EMC (Electromagnetic Compatibility) regulatory standards 73

Declaration of conformity 74

FCC Class B device 75

## Material Safety Data Sheets for Phaser 850 Printers

## Specifications for Phaser 850 Printers

## Index 86

# Printer Management

## PhaserLink Printer Management software

PhaserLink Printer Management software is a printer management tool that uses World Wide Web technology to provide printer information and functionality:

- Job status
- Job accounting
- Printer usage
- Routine troubleshooting
- Configuration of printer settings

PhaserLink requires a TCP/IP connection. To access PhaserLink information, enter your printer's IP address in a web browser. The PhaserLink interface appears on your computer's screen.

For detailed information on PhaserLink Printer Management software, refer to “*PhaserLink Printer Management software: The Printer's Information Link*” on the printer's CD-ROM or web site. Or enter this address in your web browser:

**[www.tektronix.com/Color\\_Printers/products/phaserlink.html](http://www.tektronix.com/Color_Printers/products/phaserlink.html)**

## Job Accounting

The printer stores a log file containing information about jobs printed. The file is a list of job accounting records. Each record contains fields such as user name, job name, pages printed, job times, and ink used. Job accounting is available through the PhaserShare Administrator and PhaserLink Printer Management software.

For more information on Job Accounting, see the *PhaserShare Networking Manual* on the printer's CD-ROM or web site.

## TekSMART™ Knowledge Base

**[www2.tek.com/TekSMART/](http://www2.tek.com/TekSMART/)**

- Application issues
- Networking issues
- Printer errors
- Print quality issues
- Troubleshooting
- Latest tips from technical support

## Usage Profile

Usage Profile provides a proactive strategy for service, maintenance, and administration of your printer. With Usage Profile, you can keep track of most printer parameters in detail.

Information in the Usage Profile Report includes:

- Remaining life of consumables
- Paper versus transparency usage
- Number and location of media jams
- Media tray usage
- Number of pages printed

Print the Usage Profile report from your printer's front panel. Refer to the Menu Map for location and instructions.

In addition, you can easily arrange electronic mail notification so that your system administrator or supplies-ordering agent receives timely information on error conditions or supplies status. This feature allows you to predict the ordering needs of customer-replaceable consumables for remote locations. These types of error conditions are reported:

- For the designated operator, system administrator or service provider
  - Supplies (customer-replaceable consumables) low or out
  - Empty media tray
- For the system administrator
  - Printer configuration
- For the service provider
  - Error conditions requiring hardware service repair

For detailed information about the Usage Profile report, refer to the Tektronix web site.

# Fonts

## Resident typefaces (PostScript)

The printer accepts Adobe Type 1 and Type 3 downloadable fonts, TrueType fonts, PCL5, and a variety of user-defined fonts.

To extend font capability, the printer supports an optional internal IDE hard drive for storage of additional fonts. Refer to the printer's user guide, or the Tektronix web site, for ordering information.

ATM (Adobe Type Manager) software (provided on the printer's CD-ROM) helps your computer to display these fonts on screen as they will appear in your prints.

All printer configurations are shipped with 136 resident fonts. To print a sample of the printer's fonts, see *page 6*.

## Resident typefaces (PCL5C)

For PCL5C (Printer Command Language) printing, the printer supports Courier, Times, and Universe typefaces in medium, bold, italic medium, and italic bold. In addition, there are 46 PCL fonts. The printer port must be set to **AutoSelect** (which is the default) for the printer to accept PCL data.

## Downloading fonts

Printer-resident fonts are always available for printing. Additional downloadable fonts can be sent from your computer and stored in the printer's memory or on a hard disk. Adding more printer memory expands the number of fonts that can be stored on your printer.

Downloading fonts saves print time when printing large, or several documents, that use those fonts.

The printer accepts these (and other) downloadable fonts:

- Type 1
- Type 3
  - Adobe
  - Agfa
  - Bitstream
  - Microsoft
  - Apple
- TrueType (scalable to any point size; look the same on-screen and printed).

Before printing, make sure that the fonts specified in your document are installed in the printer or are set up correctly. If you request a font in an application that is not resident in the printer, or is not correctly installed, the text is printed in `Courier` typeface.

Refer to the printer's user guide, or the Tektronix web site, for information on ordering a hard drive for font storage.

## Downloading fonts from a Macintosh

1. Refer to *Downloading files to the printer from a Macintosh* on page 27 to locate the Apple Printer Utility on the printer's CD-ROM.
2. Within the Apple Printer Utility, click **Open Printer**; a dialog box appears.
3. Click the arrow next to **Printer Preferences**.
4. For a list of installed fonts and locations, click the arrow next to **Fonts**.
5. Click **Add**.
6. Select your font folder, then select the font you want to download.
7. Under **Destination**, select the download location: either the printer's memory or an internal hard disk.
8. Click **Add** for one font or click **Add All** for all fonts in the folder.
9. Click **Send**; the font(s) appear in the list.

### Note

To remove downloaded fonts, click **Remove**.

## Printing a list of resident fonts

### From a Macintosh

1. Refer to *Downloading files to the printer from a Macintosh* on page 27 to install and use the *Apple Printer Utility*.
2. Within the *Apple Printer Utility*, from the **File** menu, select **Print Font Samples**.

### From a PC or workstation

1. Insert the printer's CD-ROM into the CD-ROM drive.
  - If the Windows autorun feature is enabled, the CD-ROM launches automatically.
  - If the Windows autorun feature is disabled, double-click **My Computer**, then double-click the CD icon to launch the CD-ROM.
2. For **Setup Type**, select **Custom**.
3. Click **Next** until the **Choose Components and Sub-components** dialog box appears. Make the following selections:
  - Components: **Graphics Arts Files**
  - Sub-components: **Samplers**
4. Follow the on-screen instructions to complete the installation.
5. Locate the files in the folder you selected during the installation; the default is: **C:Program Files\Tektronix\Phaser xxx**, where xxx is your printer's name.
6. Refer to *Downloading files to the printer from a PC* on page 29 for file downloading instructions.

# Image Smoothing

**Image Smoothing** blends adjacent colors in low-resolution images for smoother color transitions. For example, use **Image Smoothing** to improve the appearance of a 72-dpi image downloaded from the World Wide Web. **Image Smoothing** is not recommended for 300-dpi or higher images.

There are four ways of selecting **Image Smoothing** (driver selections override all other settings):

1. In a supported driver, locate the **Image Smoothing** option:
  - **LaserWriter 8.3.4 driver:**  
In the **Print** dialog box, click **Options**.
  - **LaserWriter 8.5.1 driver:**  
In the **Print** dialog box, from the pull-down menu (General) select **Printer Specific Options**.
  - **Windows 95 / Windows 98 PostScript driver:**  
**Start/Settings/Printers**, then select **Properties** for your printer. In the **Setup** tab, select **Expert Options**.
  - **Windows 2000 driver:**  
From the **Layout** tab or **Paper/Quality** tab, click **Advanced**.
  - **Windows NT driver:**  
From the **Properties** tab, select the **Advanced** tab. From the **Document Options** tab, select **Printer Features**.
  - **Adobe PS3 driver for Windows 3.1:**  
Select the **Features** tab options.
2. Through the printer's front panel; see the **Menu Map** for location.
3. Through PhaserLink Printer Management software.
4. Through one of the following PostScript utility files (see *Printer Utilities* on page 23 for instructions):

## Macintosh

- *Image Smoothing On*
- *Image Smoothing Off*

## PC

- *SMOOTHON.PS*
- *SMOOTHOFF.PS*

# Quick Collate

## Requirements

- DP or DX Feature Set
- Hard drive (internal)

**Quick Collate** speeds the collation and printing of large print jobs and multiple sets of documents. The collate function in some software applications repeatedly sends each page in sequence to the printer until the requested number of copies is printed. With the **Quick Collate** option, the job is sent only once and then multiple collated sets are produced by the printer, allowing much faster processing time.

The number of pages that can be collated at one time depends on the size of the hard disk installed in the printer.

### Note

Make sure that you turn off the collate function in your application, because the printer's **Quick Collate** option is faster than the collate function in software applications.

In a supported driver, locate the **Quick Collate** option:

- **LaserWriter 8.3.4 driver:**  
In the **Print** dialog box, click **Options**.
- **LaserWriter 8.5.1 driver:**  
In the **Print** dialog box, from the pull-down menu (General) select **Printer Specific Options**.
- **Windows 95 / Windows 98 PostScript driver:**  
**Start/Settings/Printers**, then select **Properties** for your printer. In the **Setup** tab, select **Advanced Paper Options**.
- **Windows 2000 driver:**  
From the **Layout** tab or **Paper/Quality** tab, click **Advanced**.
- **Windows NT driver:**  
From the **Properties** tab, select the **Advanced** tab. From the **Document Options** tab, select **Printer Features**.
- **Adobe PS3 driver for Windows 3.1:**  
Select the **Features** tab options.

## Quick Collate and 1st Page Preview

When you use the printer's **Quick Collate** option with **1st Page Preview**, only the first page of the first set is printed before pausing for your review.

# Separation Pages

You can have the printer insert a separation page, or divider page, to separate print jobs, multiple copies of a single print job, or individual pages of a print job.

There are two selections to make in your printer driver.

1. In a supported driver, locate the **Separation Page** options:
  - **LaserWriter 8.3.4 driver:**  
In the **Print** dialog box, click **Options**.
  - **LaserWriter 8.5.1 driver:**  
In the **Print** dialog box, from the pull-down menu (General) select **Printer Specific Options**.
  - **Windows 95 / Windows 98 PostScript driver:**  
**Start/Settings/Printers**, then select **Properties** for your printer. In the **Setup** tab, select **Advanced Paper Options**.
  - **Windows 2000 driver:**  
From the **Layout** tab or **Paper/Quality** tab, click **Advanced**.
  - **Windows NT driver:**  
From the **Properties** tab, select the **Advanced** tab. From the **Document Options** tab, select **Printer Features**.
  - **Adobe PS3 driver for Windows 3.1:**  
Select the **Features** tab options.
2. Select one of the following for **Separation Page**:
  - **Off:** Turns off the Separation Page feature.
  - **End of Job:** Inserts a separation page between individual print jobs.
  - **End of Set:** Inserts a separation page between copies, or sets, of a multi-copy print job.
  - **End of Page:** Inserts a separation page between every page of a print job.
3. Select one of the following for **Separation Page Source**:
  - **Upper Tray:** Takes paper for the separation page from the upper media tray.
  - **Middle Tray:** Takes paper for the separation page from the middle media tray, if you have optional paper trays installed.
  - **Lower Tray:** Takes paper for the separation page from the lower media tray, if you have optional paper trays installed.

# PANTONE Colors

For the latest information on color libraries, visit the Tektronix web site at:

[www.tektronix.com/Color\\_Printers/](http://www.tektronix.com/Color_Printers/)

or contact your local Tektronix reseller.

PANTONE Color files for your printer include printer-specific color library files for some specific applications and a file to print the PANTONE Color sampler chart.

## Methods of printing PANTONE Colors

### PANTONE Colors from color selection books

In some applications, you can select colors from PANTONE Color selection books. These colors can be proofed on your Phaser printer before final output on a printing press. For this method, the printer-specific PANTONE Color files are not required.

1. From an application, select and apply PANTONE Colors; use individual color values from a PANTONE Colors selection book.
2. Print your document; from a supported driver, select the Commercial Press color correction. (Proof colors may not be completely accurate, but PANTONE Colors will be printed correctly on a printing press.)
3. When you are satisfied with the proof, the file can be separated for printing press plates without adjustment to the file.

### Printer-specific PANTONE Colors

Your printer can produce process color simulations of PANTONE Spot Colors.

1. Print a copy of the PANTONE Color chart. Refer to *Printing the PANTONE Color Chart* on page 12.
2. Within an application, define the desired color in your document by using the individual CMYK values which appear on the sampler chart.
3. Print your document. For best results, use the same printer settings for color correction and print quality, and the same type of paper that you used to print the PANTONE Color chart.

### For final output on a color printing press

For colors to be printed as a process color (no spot colors), follow these steps:

1. Open the application.
2. Before separating the file for printing press plates, replace the printer's PANTONE process Colors with standard PANTONE Colors.

## Installing the PANTONE Color files

### From the Web

1. Download the appropriate PANTONE Color file for your printer from the Tektronix web site:  
**[www.tektronix.com/Color\\_Printers/](http://www.tektronix.com/Color_Printers/)**
2. Choose a directory location, and extract the file.

# Printing the PANTONE Color Chart

## Macintosh

### Printing individual pages from Acrobat Reader

1. You will need to install Acrobat Reader if you want to print individual pages from the PANTONE Color chart. Insert the printer's CD-ROM in your computer's drive, go to the *Utilities* folder, and install Acrobat Reader onto your computer's hard disk; follow on-screen instructions.
2. After Acrobat Reader is installed, locate the Pantone files you downloaded from the web site. Double-click the desired PDF file.
3. View and print pages from the PDF file. For best results, print on paper.

### Note

Print only with the None Color Correction setting; other settings cause PANTONE Colors to print differently than expected.

### Printing the entire chart

- Use the *Apple Printer Utility* to download to the printer the desired PANTONE Color PostScript file, refer to *page 23* for instructions. This PostScript file contains necessary color correction and print quality settings.
- For best results and truest color:
  - Print the chart on paper that is similar to the paper that will be used on the printing press.
  - Turn off two-sided printing when printing the color chart in order to reduce the effects of color show-through.

## PC

### Printing individual pages from Acrobat Reader

1. You will need to install Acrobat Reader if you want to print individual pages from the PANTONE Color chart. Insert the printer's CD-ROM in your computer's drive, go to the *Utility* directory, and install Acrobat Reader onto your computer's hard disk; follow on-screen instructions.
2. Click Start, then Programs, then the program folder you selected; the default is the printer's name.
3. Select the PDF file.
4. View and print pages from the PDF file. For best results, print on paper.

### Note

Print only with the None Color Correction setting; other settings cause PANTONE Colors to print differently than expected.

### Printing the entire chart

Print the PANTONE Color chart by sending the PANTONE PostScript file to the printer. Refer to *page 23* for downloading instructions.

- For best results and truest color:
  - Print the chart on paper that is similar to the paper that will be used on the printing press.
  - Turn off two-sided printing when printing the color chart in order to reduce the effects of color show-through.

# PhaserPrint Plug-in for Photoshop

The PhaserPrint™ plug-in, included on the printer's CD-ROM, operates within the Photoshop application. With PhaserPrint, you can improve image transfer time and gain easy access to Tektronix printer features and other media features.

PhaserPrint software produces correct output only on supported Tektronix printers.

## Note

If you use this plug-in with a printer not listed in the PhaserPrint dialog box, the image may be placed incorrectly on the page, or colors may look incorrect, or your file may not print.

## Installing the plug-in: Macintosh

### Note

The PhaserPrint Plug-in is automatically installed with the software installation option **Easy Install**.

### Compatibility requirements

- Photoshop 2.5.1 and higher
- System 7.0 and higher

### Installing the plug-in

1. From the printer's CD-ROM, run the *Installer* application. Select **Custom Install**.
2. Select **PhaserPrint plug-in for Photoshop**. Click **Install**; the file is installed in the Photoshop application's *Plug-ins* folder on your computer's hard disk.

## Installing the plug-in: Windows

### Compatibility requirements

- Photoshop 4.0 and higher
- Windows 95/Windows 98 or Windows NT
- (optional) TCP/IP support requires proper installation of IP networking software and cards

### Installing the plug-in

1. Insert the printer's CD-ROM into the CD-ROM drive.
  - If the Windows autorun feature is enabled, the CD-ROM launches automatically.
  - If the Windows autorun feature is disabled, double-click **My Computer**, then double-click the CD icon to launch the CD-ROM.
2. For **Setup Type**, select **Custom**.
3. Click **Next** until the **Chose Components and Sub-components** dialog box appears. Make the following selections:
  - Components: **Printer Driver**
  - Sub-components: **Photoshop plug-in**
4. Follow the on-screen instructions to complete the installation.

## Using the plug-in

1. If you don't already have a default printer selected, do the following:
  - **Macintosh:**
    - a. Open the **Chooser**.
    - b. Select a PostScript driver (such as the Apple LaserWriter 8); select your printer. PhaserPrint software works like a printer driver, and prints to the printer you selected in the Chooser.
  - **Windows:**
    - a. Click **Start**, then **Settings**, then **Printers**.
    - b. Right-mouse-button-click on your printer's icon.
    - c. In the pop-up menu, select **Set as Default**.
    - d. Within the PhaserPrint software, select your printer and port, as described in *Print using (Windows)* on page 18.
2. Open Photoshop. Open an image file.
3. From the **File** menu, select **Export**. Select **PhaserPrint**; the PhaserPrint dialog box appears.
4. In the **Printer Model** field, select your printer.
5. PhaserPrint software supports the following image modes selected from Photoshop's **Mode** menu. If you select a mode not listed here, an error message appears and your image is not printed.
  - Bitmap
  - Grayscale
  - Indexed Color
  - RGB Color
  - CMYK Color
  - Lab Color

## Selecting options in the PhaserPrint dialog box

Settings you make in the PhaserPrint plug-in remain in effect until you change them. The exception is Number of Copies, which defaults to 1 each time you start the plug-in.

### Note

You can get information on any of the plug-in's features or printer-specific options with the online **Help** function.

### Number of copies

Enter the number of copies to print, from 1 to 1000.

### Print using (Macintosh)

The **Print using** pop-up menu lets you choose between printing an image or saving the image to disk.

- **AppleTalk:** Prints the image to the printer currently selected in the Chooser; the currently selected printer name is displayed in the **Printer model** field. If the selected printer is not a PostScript printer, this option is unavailable (grayed-out).
- **PostScript file:** Saves an image to disk as a PostScript file. Click **Save**; a dialog box lets you choose a new or existing file for saving the PostScript code.

When selected, the **File format** pop-up menu becomes available. This pop-up menu has two options: **ASCII base-85** and **Binary**.

- **ASCII base-85:** Image data is encoded using an ASCII base-85 filter during file output, making the resulting PostScript file portable, and downloadable through interface ports that don't support binary data. Note that the file may be up to 25% larger.
- **Binary:** Image data is output in binary format.

## Print using (Windows)

The **Print using** pop-up menu lets you choose between printing an image or saving the image to disk. It has two to four options, depending on your system configuration:

- **TCP/IP:** Available if a TCP/IP stack is installed and running. From **Printer model**, choose a printer. Add and delete printers in the list, and edit the printer configurations. TCP/IP is the fastest printing method; it prints jobs in much less time than the Local Port or Printer Driver methods, and is the recommended method if it is available for the printer you are using.
- **Local Port:** Available if you have local ports installed in your PC. From the **Port Name**, choose the desired printer port.
- **Printer Driver:** Prints the image through the selected printer driver. From **Driver Name**, choose a printer.
- **PostScript file:** Saves an image to disk as a PostScript file. Click **Save**; a dialog box lets you choose a new or existing file for saving the PostScript code.

When selected, the **File format** pop-up menu becomes available. This pop-up menu has two options: **ASCII base-85** and **Binary**.

- **ASCII base-85:** Image data is encoded using an ASCII base-85 filter during file output, making the resulting PostScript file portable so that it can be downloaded through interface ports that don't support binary data. Note that the file may be up to 25% larger.
- **Binary:** Image data is output in binary format. Recommended for network printing only (not for the parallel port).

## Printer model

- Displays the currently selected printer.
- Lists all printers supported by PhaserPrint software.
- When you select your printer model, PhaserPrint displays the correct options for your printer.

## Media size (selection)

- Paper sizes are printer-specific; refer to the online Help for your printer's options. Before selecting a paper size, select your printer in the **Printer model** field.

## Color Correction

- Color Corrections are not available if **Lab** is the selected **Mode** in Photoshop.
- If **RGB** is the selected **Mode** in Photoshop, the **Calibrated RGB** option is also available.

## Media

- The setting remains in effect until you change it.

## Quality

- The setting remains in effect until you change it.

## Rendering Intent

- Available in the following cases:
  - If the **Mode** in Photoshop is **RGB**, and you select **Calibrated RGB** as the Color Correction in PhaserPrint.
  - If the **Mode** in Photoshop is **Lab**.
- **Calibrated RGB** and **Lab** modes take longer to print than other modes because the printer must convert CIE colors to RGB or CMYK colors before printing.

## Compress Image Data

- Compresses image data so that less data is sent to the printer or stored in a file.
- Useful if your network connection is slow, for example, if you are connected to a busy network or if you are using a parallel port. For fast networks, printing may be faster without using this option.
- The setting remains in effect until you change it.
- Default is On.

## Fast preview

- Quick print of your image with slightly reduced image quality.
- Reflects the printer color correction you selected.
- For the fastest printing, use the **None** color correction option.
- Default is **Off**.

## 1st Page Preview

- Available only with the printer's DP or P, and DX Feature Set options.
- When sending a multiple-copy print job to the printer through the driver, you can select **1st Page Preview** to preview the first page of the job, and determine if the job is printing as expected before proceeding with the remainder of the job. This option is especially useful when printing many copies.
  - a. Click the **1st Page Preview** check box.
  - b. Check your first print. At the **1st Page Preview** message on the printer's front panel, select one of the following:
    - **Reprint:** Reprints the first page, the printer pauses again for the duration of the selected timeout, or until you press one of the buttons.
    - **Cancel:** Cancels the print job.
    - **Continue:** Continues printing the entire job.
- At the printer's front panel, set the **1st Page Preview** timeout.
- Default is **Off**.

## Image Smoothing

- Blends adjacent colors so that color transitions are less noticeable.
- Use this option when the image being printed was scanned at a lower resolution than the printer's output resolution. For example, printing an image scanned at 72 dpi using the printer's Standard print quality mode.
- Images printed using **Image Smoothing** appear with less sharp detail but with smoother color transitions.
- Default is **Off**.

## Stylized representation of the page

- The lower left area of the dialog box displays a stylized representation of the page as it would look when printed using the current selections in the **Scale**, **Scale to fit**, **Printer model**, **Media size** (selection), **Landscape orientation**, **Replicate images**, **Center images**, and **Image separation** options. When you change any of these selections, the representation of the page is redrawn to reflect the new selection.
- If **Show color preview of image** is **On**, an approximate color image is displayed.

## Scaling an image

- **Scale to fit**
  - Scales an image to the largest size that fits the image area of the currently selected page size or orientation.
  - Automatically updates the **Scale** field value.
- **Scale**
  - Type the percentage the image should be scaled, from 10 percent to 2000 percent.
  - Use with the **Replicate images** option to produce multiple copies of an image on a single page.
- Alert message: **Image clipping will occur.**

This message appears in the PhaserPrint dialog box whenever a scaled image will not fit within the image area of the currently selected page size or orientation option.

## Landscape orientation

- Prints the image horizontally (landscape) on the page. Leave this box unchecked to print the image vertically (portrait) on the page.
- Refer to the **Stylized representation** of the page, in the lower left corner of the dialog box, to see how your selection will look when printed.

## Center images

- Centers the image in the page's image area.
- If this box is not checked, the lower left corner of the image is aligned with the lower left corner of the printable area of the page.
- If the **Center images** box is checked and the **Replicate images** box is checked, the set of replicated images are centered in the image area of the page.

## Replicate images

- Fills the page's image area with as many copies of the image as will fit.
- The size of each replicated image is determined by the setting in the **Scale** text box.
- If the size of each replicated image (shown as black rectangles in the stylized representation of the page) is too small to display, the total image area of the printed page is shown as a single gray rectangle.

## Image size

- Reflects the dimensions, in inches or millimeters, of the image.
- If the value in the **Scale** box is out-of-range, the image dimensions are displayed with question marks.

## Image separation

- Only available if the **Replicate images** box is checked.
- Type an amount, in inches or millimeters (depending on your measurement standard), to specify the amount of separation between each replicated image.
  - A larger amount reduces the number of images that can be printed at one time.
  - Minimum allowed separation value is 0.
  - Maximum separation value is 100 mm (4 inches).
  - Default separation value is 3.175 mm (0.125/one-eighth inch).
  - Valid characters for this field are 0 to 9 and a period (or decimal point).
  - As you type a value, the stylized representation of the page, and **Number of images** and **Image layout** values are dynamically updated. If the value entered in the Image separation field is out-of-range, the values in these other fields are replaced by question marks, and no images are shown in the stylized representation of the page. If the value is out-of-range, and you click **Print** or **Save**, the following alert is displayed:  
*The value for Image separation is out of range. It will be replaced with the closest allowed value.*

## Number of images

- Displays the number of scaled images that will fit in the image area of the currently selected **Media size** (selection) and **Landscape orientation** options.
- **Number of images** reflects the current Image separation value.
- If the **Replicate images** box is not checked, this number is set to **1**.
- If either **Scale** or **Image separation** values are out-of-range, a question mark is displayed.

## Image layout

- Shows how the scaled images will fit horizontally and vertically in the image area of the currently selected **Media** and **Landscape orientation** options.
- Image layout reflects the current **Image separation** value.
- If the **Replicate images** box is not checked, this number is set to **1 x 1**.
- If either **Scale** or **Image separation** values are out-of-range, question marks are displayed.

## Media size (display)

Reflects the dimensions, in inches or millimeters, of the selected media size.

## Show color preview of image

Displays an approximate color image, rather than a black box, in the **Stylized representation of the page** field.

# Printer Utilities

In addition to using the printer's front panel or the options in a supported driver, the printer's utility files offer another method for changing the way the printer operates. In some cases, a selection can only be made with a utility file.

Utility files control print features such as color correction and enabling or disabling the Startup Page. However, printer features that are selected from a driver override utility file settings and front panel settings.

There are three places to locate utility files:

- The printer's CD-ROM
- Tektronix' ftp site
- Tektronix' World Wide Web site
- Phaser Hard Drive (if internal IDE Hard Disk is installed)

Files can be downloaded to the printer:

- From a Macintosh
- From a PC

## Locating the files on the printer's CD-ROM

### Installing the utility files for Macintosh

#### To install the Apple Printer Utility and the Samplers (color charts):

1. From the printer's CD-ROM, run the *Installer* application. Select **Easy Install**.
2. In the *PhaserTools* folder on your computer's hard disk, locate the *Samplers* (color charts) and the *Apple Printer Utility*.

#### To install the printer's utility files:

1. On the printer's CD-ROM, locate the *PhaserTools* folder, then the *Printer Utilities* folder.
2. Copy the *Printer Utilities* folder, or individual files, to your computer's hard disk, or use the files from the CD-ROM.

### Installing the files for PC

#### Locating the printer's utility files:

1. Insert the printer's CD-ROM into the CD-ROM drive.
  - If the Windows autorun feature is enabled, the CD-ROM launches automatically. At the opening screen, click **Exit**.
2. In the taskbar on your screen, click **Start**, then **Programs**, then **Windows Explorer**. Select the CD-ROM.
3. Locate the utility files on the CD-ROM in the **phsrxxx** folder inside the **utility** folder (where *phsrxxx* is your printer's name). Use the files on the CD-ROM or copy the files to your computer's hard disk.

#### Installing the Sampler (color charts and font sampler) files:

1. Insert the printer's CD-ROM into the CD-ROM drive.
  - If the Windows autorun feature is enabled, the CD-ROM launches automatically.
  - If the Windows autorun feature is disabled, double-click **My Computer**, then double-click the CD icon to launch the CD-ROM.
2. For **Setup Type**, select **Custom**.
3. Click **Next** until the **Choose Components and Sub-components** dialog box appears. Make the following selections:
  - Components: **Graphics Arts Files**
  - Sub-components: **Samplers**
4. Follow the on-screen instructions to complete the installation.
5. Locate the files in the folder you selected during the installation; the default is: **C:\Program Files\Tektronix\Phaser xxx**, where xxx is your printer's name.

## Locating files on the Tektronix World Wide Web site

Tektronix has a site on the World Wide Web that you can reach from a web browser, at the following address:

**[www.tek.com/Color\\_Printers/](http://www.tek.com/Color_Printers/)**

At the Tektronix Color Printer home page, explore options such as customer support documents and new product information. New and updated information is always being added, so check the web site frequently.

Use a web browser such as Netscape Navigator, and follow these steps.

1. Start your web browser and enter the following address:  
**[www.tek.com/Color\\_Printers/support/software.html](http://www.tek.com/Color_Printers/support/software.html)**
2. From the pull-down menus, select your printer, computer, and type of file.
3. Select the files you need; they are downloaded to your computer.

## Locating files on the Tektronix FTP server

Utility files included on the printer's CD-ROM let you set up the printer from UNIX and VMS workstations to select between media trays, print quality modes, color correction modes and other features. If you don't have the means to transfer these files from the CD-ROM, you can request files from the Tektronix anonymous ftp server.

If you can exchange electronic mail with other Internet sites, you can access the Tektronix ftp server. From this server you can retrieve driver and utility files and color printer information either with a web browser or command prompt.

### From a web browser:

1. Start your web browser application.
2. Type this address:  
**ftp://ftp.tek.com/**
3. From the pull-down menus, select your printer, computer, and type of file.
4. Select the files you need; they are downloaded to your computer.

### From the command line:

1. At the system prompt, type the following: **ftp ftp.tek.com**  
The system responds: Name (ftp.tek.com:<login name>):
2. Type: **anonymous**. Press **Return**.  
The system responds: **Guest login ok, send your complete e-mail address as password.**
3. Enter your e-mail address. Press **Return**.
4. Change directories to your printer-specific directory:  
**cd Color\_Printers/UNIX/Phaser\_850/utilities**
5. Download the utility files; type: **mget \***  
The system prompts you for each file in the directory, to which you respond **y** (yes) or **n** (no).
6. Exit the ftp session: type **quit** or **bye**; press **Return**.

# Downloading files to the printer from a Macintosh

## Using the Apple Printer Utility to download files

All PostScript utility files on the printer's CD-ROM can be downloaded to the printer with the Apple Printer Utility.



To download PostScript utility files, follow this procedure:

1. From the *PhaserTools* folder on your computer's hard disk, double-click *Apple Printer Utility*.
2. In the **Printer Selector** dialog box, make the following selections:
  - Under **AppleTalk Zones**, select your printer's zone.
  - Under **Printers**, select your Phaser printer.
  - Click **Open Printer**.
3. From the **File** menu, select **Send PostScript File**; the **Select the PostScript files to download** dialog box appears.
4. Select the folder location of the PostScript file(s) that you want to download. The printer's PostScript utility files are located on the CD-ROM in the Printer Utilities folder inside the Phaser Tools folder.
5. Select a utility file. Click **Add**.
6. Click **Send**.
7. At the prompt **Save PostScript output as**, you are asked for a file name for saving printer output. Use the default name given in the edit box or type a new name. (Printer output includes status messages generated by the printer reporting such conditions as out of paper.)
8. Click **Save**.
9. If no output is returned by the printer, the Apple Printer Utility displays a dialog box; click **Continue**. If output is returned by the printer, you won't see this dialog box.  
Check your computer's hard disk for the message file created by the utility.

To download fonts, see *page 5* for additional information.

To print a font sampler, see *page 6* for additional information.

To download color sampler charts, see *page 38* for additional information.

## Using the Apple Printer Utility to perform other tasks

In addition to downloading PostScript files and fonts, you can use the Apple Printer Utility to perform the following specialized tasks.

### Note

If your printer is connected through a print server, you can only use the Apple Printer Utility to download PostScript utility files.

### Turning on/off the Startup Page

1. Double-click **Apple Printer Utility**.
2. In the **Printer Selector** dialog box, make the following selections:
  - Under **AppleTalk Zones**, select your printer's zone.
  - Under **Printers**, select your Phaser printer.
  - Click **Open Printer**.
3. Click the arrow next to **Printer Preferences**; a list of options appears.
4. Click the arrow next to **Startup Page**.
5. Click one of the following:
  - **On**: Prints a Startup Page each time the printer is turned on or reset.
  - **Off**: Stops the Startup Page from automatically printing.
6. Click **Send**.

### Changing the printer's AppleTalk name

1. Double-click **Apple Printer Utility**.
2. In the **Printer Selector** dialog box, make the following selections:
  - Under **AppleTalk Zones**, select your printer's zone.
  - Under **Printers**, select your Phaser printer.
  - Click **Open Printer**.
3. Click the arrow next to **Printer Preferences**; a list of options appears.
4. Click the arrow next to **Name**.
5. In the text box, type the new printer name.
6. Click **Send**.

## Downloading files to the printer from a PC

### Downloading files from Windows 3.1

1. Select the utility file you want to send to the printer, for example *RESET.PS*.
2. From the **File** menu, select **Copy**; the **Copy** dialog box appears with the utility file you selected listed in the **From** field.
3. In the **To** field, type the port your printer is connected to. For example, type **LPT1:** for a parallel port connection. Click **OK**.
4. If the **Confirm File Replace** dialog box appears, click **Yes** to continue; the file is downloaded to the printer.

### Downloading files from Windows 95 / Windows 98

1. Select the utility file you want to send to the printer, for example *RESET.PS*.
2. In the taskbar on your screen, click **Start**, then **Programs**, then **MS-DOS Prompt**.
  - Change directory to the location of the utility files.
  - If your printer is connected to the parallel (LPT) port, type the following command (where **x** is 1, 2, or 3): **COPY RESET.PS LPTx:**

### Downloading files from Windows NT

1. Select the utility file you want to send to the printer, for example *RESET.PS*.
2. In the taskbar on your screen, click **Start**, then **Programs**, then **MS-DOS Prompt**.
  - Change directory to the location of the utility files.
  - If your printer is connected to a network, type the following command:  
**lpr -S <IP Address> -P PS RESET.PS**

## Downloading files if your printer is connected to a Novell Netware network

This procedure lets you redirect (capture) LPT ports in Novell NetWare. NetWare queues can be captured from the DOS Prompt or captured directly from Windows. To find out if an LPT port is already captured, type the following command from the DOS Prompt:

**capture show**

This will list the current capture data for each virtual port.

### Note

If an **ad** command or file name error occurs, run the command from the file servers Public directory.

- For NetWare 3.xx and Netware 4.xx bindery queues:

**capture q=[queue\_name] l=[port] nb nff nt**

where *queue\_name* is the name of the queue to be captured, and *port* is the virtual port to capture to, such as LPT3.

Also, *nb* is no banners, *nff* is no form feeds, and *nt* is no tabs.

For example: **capture q=phaser\_350 l=3 nb nff nt**

### Note

For NetWare 4.xx NDS queues, the queue name needs to start with a period. For example: **capture q=.phaser\_350\_q.nds.printers.support l=2 nb nff nt.**

- For Windows 95 / 98 environments follow these guidelines:

1. From the Details tab of your printer's driver, select the Capture Printer Port button.
2. Select the appropriate virtual port under the Device field.
  - For bindery queues, enter the path as **\\server\_name\queue\_name** and select OK. For example: **\\nw\_server\Phaser\_350**
  - For NDS queues, enter the path as **\\Tree\queue\_name.context** and select OK. For example: **\\Tek\.Phaser\_350\_Q.nds.printers**

- For Windows 3.1x environments follow these guidelines:

1. From the Windows Control Panel, select Printers.
2. Select the Connect button, then select the Network button.
3. Choose a Port to capture, then locate the appropriate queue.

### Note

If the appropriate file server is not listed, click the Attach button and select the desired file server. Login and click OK. Within the Operation section, check the box next to the word Permanent, then click Connect. The port should then be captured.

## Downloading files if your printer is connected through PhaserPort

This procedure lets you create the printer and then redirect the port, turning client #1 into a print server.

1. On Client #1, create a printer using the LPT1 port.
2. Share the printer to the network.
3. Install Phaserport and switch the LPT1 port to the Phaserport port.
4. On client #2, browse the network and install the shared printer.
5. Open the printer's Properties.
  - a. Click Start, select Settings, and then select Printers.
  - b. Right-mouse-click on the printer's icon.
  - c. In the pop-up dialog box, select Properties.
  - d. In the Details tab, click Capture Port and enter the path.

## Downloading files if your printer is connected to Windows NT

This procedure lets you redirect (capture) LPT Ports

Under Windows NT print spooler, you create Ports based on their physical location:

- Local ports = Lpt1 / Lpt2, etc.
- IPX Port = \\NW\_SERVER\Phaser
- Appletalk Ports = WV Net 36:Phaser
- TCP/IP Ports = 162.36.62.151:PS or [AUTO]

However, if you're at a command prompt (DOS Prompt) and want to print, or copy, a PostScript file to a port that is a network port, you can do the following:

- TCP/IP Ports:

**lpr -S [printers IP Address] -P [print queue] filename**

For example: lpr -S 134.62.36.70 -P PS test.ps

- IPX and Appletalk ports require the redefinition of the LPTX port to the network path through the use of the NET USE command.

**NET USE LPT1 \\Server\_Name\Queue\_Name**

For example: NET USE LPT1 \\NW\_SERVER\Phaser

or: NET USE LPT2 \\NT\_SERVER\_NT\Phaser

After redirecting the port using the NET USE command you can use the COPY command to print the postscript file.

eg. C:\> COPY TEST.PS LPT1:

When finished, end the redirect with the command:

NET USE LPT1 /delete

# Advanced Printing Features for Phaser 850 Printers

## Previewing with 1st Page Preview

When printing multiple pages through the driver (either multiple copies of a single page or a multiple-page file), select **1st Page Preview** to preview the first page of the job before proceeding with the remainder of the job; this feature is useful when printing a large job.

You can set the timeout in the printer's front panel (timeout is the amount of time the printer waits after sending the first page of a file before it continues with the remainder of the job). The default timeout is 5 minutes.

### Requirements

- DP or DX Feature Set
- Turn on the feature in the printer driver

### Use 1st Page Preview

1. In a supported driver, select **1st Page Preview**:
  - **LaserWriter 8.3.4 driver:**  
In the **Print** dialog box, click **Options**.
  - **LaserWriter 8.5.1 driver:**  
In the **Print** dialog box, from the pull-down menu (General) select **Printer Specific Options**.
  - **Windows 95 / Windows 98 PostScript driver:**  
**Start/Settings/Printers**, then select **Properties** for your printer. In the **Setup** tab, select **Expert Options**.
  - **Windows 2000 driver:**  
From the **Layout** tab or **Paper/Quality** tab, click **Advanced**.
  - **Windows NT driver:**  
Under the **Properties** tab, select the **Advanced** tab. In the **Document Options** tab, select **Printer** features.
  - **Adobe PS3 driver for Windows 3.1:**  
Select the **Features** tab options.
2. Check your first print. At the printer's front panel **1st Page Preview** message, choose one of these options:
  - **Reprint:** Reprints the first page, pauses for the duration of timeout or until you press a button.
  - **Cancel:** Cancels the print job.
  - **Continue:** Prints the rest of the print job.
3. Press **Select**.

## Reset the timeout

1. In the front panel, scroll to **Menu**; press **Select**.
2. Scroll to **Printer Configuration**; press **Select**.
3. Scroll to **Default Printer Settings**; press **Select**.
4. Scroll to **1st Page Preview Timeout**; press **Select**.
5. To change the timeout (the amount of time the printer pauses before completing the print job), press the up or down arrows; press **Select**.
6. To exit, scroll to **Exit** and press **Select**.

### Note

You can also control the default timeout for **1st Page Preview** through PhaserLink Printer Management software. For details on PhaserLink Printer Management software, refer to the *PhaserShare Networking Manual* on the printer's CD-ROM or Tektronix web site.

## Automatic tray switching

When your printer has a High-Capacity Paper Tray Assembly, you can easily run large jobs without having to replace paper often. The printer automatically takes paper from the next tray when the first tray runs out.

1. For automatic tray switching to work properly, load the same type and size paper in all of the printer's paper trays.
2. Install a tray in each of the printer's tray slots.
3. In the printer driver, select **Paper** as the source.

## Front Panel Intensity

You can adjust the intensity of the front panel's back lighting.

1. In the printer's front panel, scroll to **Menu**; press **Select**.
2. Scroll to **Printer Configuration**; press **Select**.
3. Scroll to **Default Printer Settings**; press **Select**.
4. Scroll to **Set Front Panel Intensity**; press **Select**.
5. To change the front panel back light intensity (0 is no back light, 10 is the brightest back light), press the up or down arrows.
6. To activate your selection, press **Select**.
7. To return to the **Ready to Print** message, scroll to **Exit**; press **Select**.

## Intelligent Ready mode

Intelligent Ready mode is an automated system that monitors the printer's usage and warms up the printer when you are most likely to need it. You can set Intelligent Ready mode with PhaserLink or the printer's front panel. The front panel only allows you to turn Intelligent Ready mode On or Off; use PhaserLink to make other settings.

1. In the printer's front panel, scroll to **Menu**; press **Select**.
2. Scroll to **Printer Configuration**; press **Select**.
3. Scroll to **Default Printer Settings**; press **Select**.
4. Scroll to **Advanced Printer Settings**; press **Select**.
5. Scroll to **Intelligent Ready**.
6. Press **Select** to turn this option **On** or **Off**.
7. To return to the **Ready to Print** message, scroll to **Exit**; press **Select**.

### Note

You can also turn on the Intelligent Ready mode and set your own printer warm-up times through PhaserLink Printer Management software. For details on PhaserLink Printer Management software, refer to the *PhaserShare Networking Manual* on the printer's CD-ROM or Tektronix web site.

# Color Sampler Charts for Phaser 850 Printers

## Overview

Color sampler charts are colored rectangles with each color's component values; they help you select colors in an application that can be reproduced on your printer.

Component values are percentages of each color — CMYK (Cyan, Magenta, Yellow, Black), RGB (Red, Green, Blue), or HSB (Hue, Saturation, Brightness) — that combine to make a particular color.

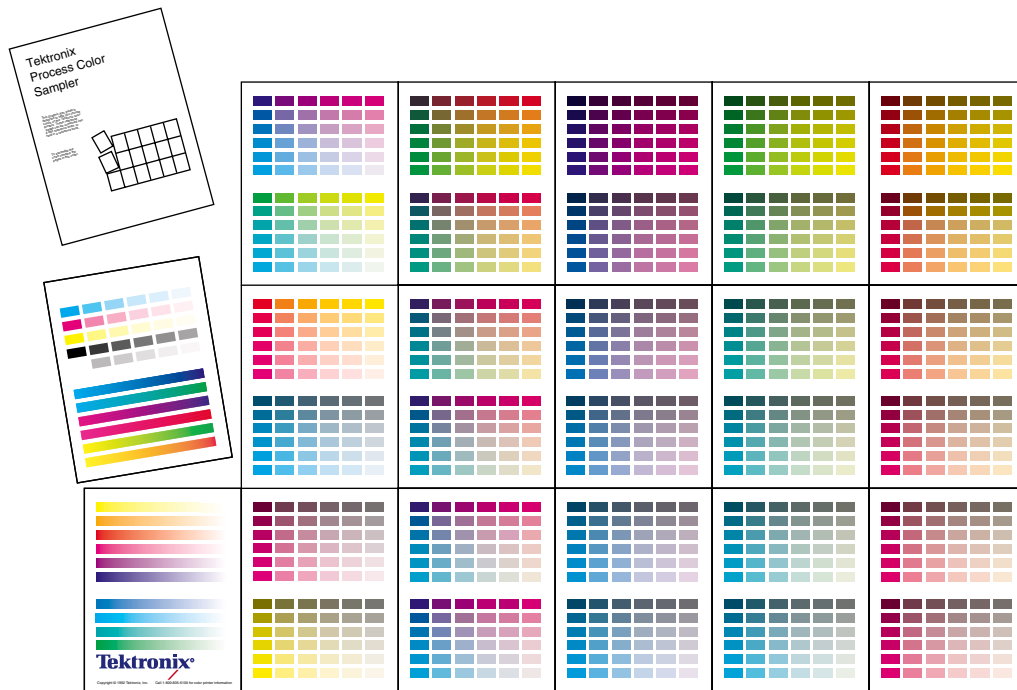

9103-64

## Color charts

- Which color chart you print and use depends on how your application selects color. For information on color selection, refer to the application's documentation, then print one or more of the color sampler charts.
- Each color sampler chart is several pages long; print them in panels and connect them to form a wall chart or place in a binder for easy reference.

### Color sampler chart descriptions

Color sampler chart		Number of pages *	Utility file	Front panel selection	PhaserLink
CMYK Sampler	Cyan, magenta, yellow, and black color model	18	X	X	X
RGB Sampler	Red, green, and blue color model	12	X	X	X
HSB Sampler	Hue, saturation, and brightness color model	12	X		

\* The number of pages will be half with two-sided printing.

### Note

To print the PANTONE Color sampler chart, refer to *Printing the PANTONE Color Chart* on page 12.

## Printing a color sampler chart from the Phaser 850 printer's front panel

### Note

Use the same color correction and print quality mode to print the chart and to print from your application. Any other color correction or print quality mode selections in the driver will cause colors to print differently than expected.

### Selecting a color correction and a print quality mode

1. From the printer's front panel, use the up and down arrows to scroll to **Menu**; press **Select**.
2. Scroll to **Printer Configuration**; press **Select**.
3. Scroll to **Default Printer Settings**; press **Select**.
4. Scroll to **TekColor Correction**; press **Select**.
5. Scroll to the color correction you want; press **Select**. A checkmark appears next to your selection.
6. Scroll to **Previous Menu**; press **Select**.
7. Scroll to **Print Quality Mode**; press **Select**.
8. Scroll to the print quality mode you want; press **Select**. A checkmark appears next to your selection.
9. To return to the **Ready to Print** message, scroll to **Exit**; press **Select**.

### Printing a color sampler chart

1. From the printer's front panel, scroll to **Printer Demo** and press **Select**.
2. Scroll to the desired color sampler, then press **Select**. The color sampler prints.
3. To return to the **Ready to Print** message, scroll to **Exit**; press **Select**.

### Printing the desired colors from an application

1. Using the color sampler chart that you printed earlier, select the desired colors.
2. From your application, apply the desired colors in your document by entering the specific CMYK or RGB values as indicated on the sampler chart.
3. Print your document; select the same color correction and print quality mode that you used to print the color sampler chart.

## Printing the color sampler charts with utility files

### From a Macintosh

1. Refer to *Downloading files to the printer from a Macintosh* on page 27 to install and use the *Apple Printer Utility*. The color sampler charts are also installed during Easy Install.
2. Within the *Apple Printer Utility*, locate the color sampler chart files in the *PhaserTools* folder on your computer's hard disk and download them to the printer to print.

### From a PC or workstation

1. Insert the printer's CD-ROM into the CD-ROM drive.
  - If the Windows autorun feature is enabled, the CD-ROM launches automatically.
  - If the Windows autorun feature is disabled, double-click **My Computer**, then double-click the CD icon to launch the CD-ROM.
2. For **Setup Type**, select **Custom**.
3. Click **Next** until the **Chose Components and Sub-components** dialog box appears. Make the following selections:
  - Components: **Graphics Arts Files**
  - Sub-components: **Samplers**
4. Follow the on-screen instructions to complete the installation.
5. Locate the files in the folder you selected during the installation; the default is: **C:Program Files\Tektronix\Phaser xxx**, where xxx is your printer's name.
6. Refer to *Downloading files to the printer from a PC* on page 29 for file downloading instructions.

# Troubleshooting Phaser 850 Printers

## Useful tools

### Printer CD-ROM

- Advanced Features and Troubleshooting Manual
- Consumables instructions
- Setup Guide poster
- Video help
- Networking manuals
- Cleaning instructions
- Repacking instructions
- Printer drivers
- Material Safety Data Sheets (MSDS)

### Windows driver help system

Install the driver from the printer's CD-ROM and use the embedded help system.

- Troubleshooting information
- Access to installed manuals and videos
- Live links to the Tektronix web site

### Color Connection

#### **colorconnection.tektronix.com**

Color resource for tools and information to help you get the most out of your color printer:

- Customized support and automatic driver update notification.
- Color education with interactive tutorials and helpful hints.
- Free templates and promotions.
- Online supplies ordering
- Online documentation.

### Printer's front panel

- **Help** menu: Accesses information and tools for solving printer problems.
- **Help** button: Press at any time for additional information on displayed menu options or status messages.
- **Troubleshoot Jams** menu: Appears when paper jams, provides additional information.

## Internal printer pages

The printer has several help pages available; refer to the Menu Map for their locations.

- **Connection Setup:** connecting to a computer or network
- **Diagnostic Test Page:** how to solve print problems, such as smudges or light stripes
- **Help Guide:** Provides specific help resources.
- **Paper Tips Page:** what papers, transparencies, or labels to use
- **Supplies Page:** part numbers and descriptions

## PhaserLink™ Software

[www.tek.com/Color\\_Printers/products/phaserlink.html](http://www.tek.com/Color_Printers/products/phaserlink.html)

- View printer status using any web browser
- Control printer settings
- Link to online documentation via the World Wide Web
- Receive electronic mail when consumables are low or other printer maintenance is required
- Requires network connection via TCP/IP

## Tektronix web site

[www.tek.com/Color\\_Printers/](http://www.tek.com/Color_Printers/)

- Product and supplies information
- Finding your local reseller

## TekSMART™ Knowledge Base

[www2.tek.com/TekSMART/](http://www2.tek.com/TekSMART/)

- Application issues
- Networking issues
- Printer errors
- Print quality issues
- Troubleshooting
- Latest tips from technical support

## Other online services

---

<b>Anonymous ftp server</b>	<a href="ftp://ftp.tek.com/Color_Printers/">ftp.tek.com/Color_Printers/</a>
<b>Subscribe to email update notices</b>	<a href="http://www.colorconnection.tektronix.com">www.colorconnection.tektronix.com</a>

---

## Front panel messages

### Power indicator is blinking

Possible Causes	Solution
The printer is receiving, processing or printing a job.	Wait for the job to be completed or cancel the job.
You have entered the menu in the front panel.	Exit the menu.
Warm-up sequence has not finished.	Wait until the printer displays Ready to Print.

### Power indicator is off

Possible Causes	Solution
The printer is turned off, is not ready, is disabled, or has detected an error.	<ul style="list-style-type: none"> <li>■ Make sure that the printer is plugged in and turned on.</li> <li>■ Do not plug the printer's power cord into a power strip; use a wall outlet.</li> </ul>

### Error indicator is blinking

Possible Causes	Solution
The printer is stopped because it detected an error or condition requiring user intervention, such as an open door or a media jam.	<ul style="list-style-type: none"> <li>■ Correct the condition reported by the front panel (for example, close the door or clear the media jam).</li> <li>■ Press the <b>Help</b> button to access information on the error condition.</li> <li>■ Turn the printer off and unplug the power cord for 1 minute. Then plug in the power cord and turn on the printer.</li> <li>■ If the problem is an error that is not user-correctable, contact Customer Support.</li> </ul>

### Returns to Ready to Print without any intervention

Possible Causes	Solution
Front-panel timeout: If no activity occurs in 2 minutes, the front panel returns to <b>Ready to Print</b> .	Scroll to <b>Menu</b> and press <b>Select</b> to re-enter the menu.

## Media Jam messages

Possible Causes	Solution
Media jam.	<ul style="list-style-type: none"> <li>■ Make sure that paper or transparencies are installed correctly and that the tray's media indicator switch has been set correctly.</li> <li>■ When using the manual feed slot, make sure that the media is fed straight and aligned with the left edge of the manual feed slot.</li> <li>■ To clear the jam: Refer to the printer's front panel <b>Troubleshoot Jams</b> menu for instructions.</li> </ul>
Too much media is loaded in the media tray.	Reduce the amount of media to below the tray's maximum-capacity label.
Media is wrinkled or curled.	Change the media.
Media is too thick or too thin.	Use recommended media; refer to the printer's user guide, or print the Paper Tips Page (see the Menu Map for location.)
Media has jammed at the manual feed slot because it was not loaded properly.	<p>Re-insert the media in the manual feed slot:</p> <ul style="list-style-type: none"> <li>■ Make sure the sheet is loaded flush against the left side of the manual feed slot.</li> <li>■ Feed only one sheet at a time.</li> <li>■ Insert the sheet until it is pulled into the printer.</li> </ul>

## Media Jam - Retry manual feed

Possible Causes	Solution
An envelope has jammed because it was not loaded properly.	<p>Re-insert the envelope in the manual feed slot:</p> <ul style="list-style-type: none"> <li>■ Make sure the envelope is loaded flush against the left side of the manual feed slot with the flap side facing up. Refer to the diagram on the manual feed slot for instructions.</li> <li>■ When prompted by the front panel, feed one envelope only.</li> </ul>
A sheet of paper has jammed because it was not loaded properly.	<p>Re-insert the sheet in the manual feed slot:</p> <ul style="list-style-type: none"> <li>■ Make sure the sheet is loaded flush against the left side of the manual feed slot. Refer to the diagram on the manual feed slot for instructions.</li> <li>■ When prompted by the front panel, feed one sheet only.</li> </ul>

## Output tray full

Possible Causes	Solution
Too much media is stacked in the output tray.	Remove all printed pages from the output tray.

### Incorrect Media Size

Possible Causes	Solution
An incorrect paper size is loaded in the tray, or paper narrower than the driver selection is in the manual feed slot.	<ul style="list-style-type: none"> <li>■ Use only supported paper, transparency, and envelope sizes.</li> <li>■ Make sure the size matches the driver selection.</li> </ul>

### Ink low - Add ink

Possible Causes	Solution
One or more colors of ink are almost empty.	Add ink soon.

### Out of ink

Possible Causes	Solution
One or more colors of ink are empty.	Add ink to continue printing.

### Ink sticks jammed

Possible Causes	Solution
One or more ink sticks are stuck in the ink-loading bin.	<ul style="list-style-type: none"> <li>■ Open and close the top cover.</li> <li>■ Press each row of ink sticks in the ink-loading bin to make sure they are not jammed.</li> <li>■ Do not use broken ink sticks.</li> <li>■ Install ink sticks with the tapered side down.</li> </ul>

### Maintenance Kit Low

Possible Causes	Solution
The Maintenance Kit is almost empty.	Order a replacement Maintenance Kit.

### Maintenance Kit Empty

Possible Causes	Solution
The Maintenance Kit is depleted.	<ul style="list-style-type: none"> <li>■ Replace the Maintenance Kit to continue printing.</li> <li>■ If message remains after new kit is installed, make sure the new counter is also installed.</li> </ul>

### Maintenance Drawer (A) locked

Possible Causes	Solution
Hot ink is present.	Close the door and wait a few minutes before removing the maintenance drawer (A) from the printer.

### Maintenance Drawer (A) Missing

Possible Causes	Solution
Maintenance counter is not installed.	Install the counter.
Maintenance Drawer is not installed.	Install the Maintenance Drawer.

### Maintenance Kit Service Life Low

Possible Causes	Solution
The 2-year service life is soon to expire.	Replace Maintenance Kit soon.

### Maintenance Kit Service Life Expired

Possible Causes	Solution
The 2-year service life has expired.	Replace Maintenance Kit now.

### Printer Error ##

Possible Causes	Solution
An error occurred that may not be user-correctable.	<p>Turn the printer off and unplug the power cord for 1 minute. Then plug in the power cord and turn the printer back on.</p> <p>If the error is not cleared, write down the error number.</p> <ul style="list-style-type: none"><li>■ If you have access to the World Wide Web, look up the error number on the TekSMART web page (see <i>Useful tools</i> on page 39) for possible corrective action.</li><li>■ If the error persists, call Customer Support with the error number. See the printer's user guide for instructions.</li></ul>

## Problems with automatic two-sided printing

### Output is single-sided

- Make sure that you have selected two-sided printing in the printer driver.
- Use Letter- or A4-size paper only.
- Make sure the switch on the standard Paper/Transparency tray is set to **Paper**.

### Frequent jams with two-sided printing

- Paper must be between 60 - 150 g/m<sup>2</sup> (16 - 40 lb. bond) in weight. For better performance, use papers within the 16 - 32 lb. range.
- When using the manual feed slot, make sure that the media is always loaded straight.

### Second side of a two-sided print is upside-down

- Select the correct method for binding preference in the printer driver.
  - **Long-edge binding:** Page turns on the long side, regardless of image orientation.
  - **Short-edge binding:** Page turns on the short side, regardless of image orientation.
- Refer to the printer's user guide for detailed instructions.

### Letterhead paper prints on the wrong side or prints upside-down

- Manual feed: Load letterhead paper *face up* with the top of the page entering the printer first.
- Tray: Load letterhead paper *face down* with the top of the page at the front end of the tray.

## Problems printing on labels

### Labels are printed on the wrong side

- Make sure the labels are loaded *face up* in a tray, or *face down* in manual feed slot.
- Make sure that two-sided printing is **not** selected in the printer driver; two-sided printing is not supported for labels.

### Printing labels from Microsoft Word

1. From the **Tools** menu, select **Envelopes and Labels**.
2. In the **Envelopes and Labels** dialog box, click the **Labels** tab.
3. In the labels dialog, click on the labels Option icon.
4. In the Options field, select all of the following depending on label size:

**Letter-size:**

- a. Printer: **Laser and Ink-jet**
- b. Label Products: **Avery Standard**
- c. Select the label size corresponding to Tektronix label media:

Avery label sizes	Tektronix label media		
5160	A/Letter (U. S.) 8.5 x 11 in.	100 sheets / 30 labels per sheet (each 1 x 2-5/8 in.)	016-1812-00
5164	A/Letter (U. S.) 8.5 x 11 in.	100 sheets / 6 labels per sheet (each 3-1/3 x 4 in.)	016-1813-00

**Metric-size:**

- a. Printer: **Laser and Ink-jet**
- b. Label Products: **Avery A4 and A5 sizes**
- c. Select the label size corresponding to Tektronix label media:

Avery label sizes	Tektronix label media		
L7163	A4 (Metric Letter) 210 x 297 mm	100 sheets / 14 labels per sheet (each 38.1 x 99.1 mm)	016-1814-00
L7165	A4 (Metric Letter) 210 x 297 mm	100 sheets / 8 labels per sheet (each 67.1 x 99.1 mm)	016-1815-00

5. **For a Macintosh:** Click Print. In the Print dialog box's **General** options, for **Paper Source** select **Manual Feed Paper**.

**For a PC:** In the **Printing Options** tab, for **Feed From**, select **Manual Feed Paper**.

6. Click **Print**.

## Print Quality Problems

### Light-colored or missing stripes on prints

- Clean the printhead: in the front panel troubleshooting menu, select **Eliminate Light Stripes**. Refer to *page 55* for more information.

### Ink streaks or oil on front, back, or edges of print

- Clean the printer's internal paper path with the front panel troubleshooting routine. Refer to *Cleaning for ink smears: paper-exit path* on page 65.
- Clean the printer's paper-exit rollers. Refer to *Cleaning for ink smears: paper-exit path* on page 65.
- Clean the wiper blade in the Maintenance Drawer (A); refer to *Cleaning for oily streaks* on page 58 for instructions.
- Clean the printer's Rapid Release Guide; refer to *Cleaning for ink smears: paper-exit path* on page 65 for instructions.

### Prints have dull, faded colors

- If you are using the upper media tray, make sure that the indicator switch has been set for the appropriate media.
- Use only Phaser 850 printer transparencies; they have been specially formulated for this printer.
- For printing on transparencies, make sure that you have selected in the driver **Transparency** (for the media tray) or **Manual Feed Transparency** (for the manual feed slot).
- Try a different color correction mode or increase the print quality mode. Refer to the printer's user guide for more information.

### Photographic images appear grainy

- In the printer driver, select the highest print quality mode.
- Use images that are 150 dpi or higher.

### Black-and-white prints instead of color

- In the printer driver, check if the TekColor Correction is set to **Black and White**; if it is, choose a different color correction.
- **Macintosh users:**
  - Make sure that you are using the correct PPD file with the latest Apple LaserWriter printer driver (version 8.3.4 or higher), that supports color PostScript.
  - In the **Print** dialog box, make sure that **Color/Grayscale** is selected. Some applications require special files to print in color. Make sure that these files are properly installed. For information, refer to the topics on the printer's CD-ROM or the Tektronix World Wide Web site.

**Black-and-white prints instead of color, cont.**

■ **PC users:**

- Be sure to use the printer driver on the printer's CD-ROM.
- Make sure the application you are using is set up to print in color.

**Blue colors look too purple**

- If printed blue colors look too purple, print your document with the **Vivid Color** color correction. Refer to the printer's user guide for information on color corrections.

**Transparency print quality poor.**

- Use only Phaser 850 printer transparency media.
- Make sure that you have selected **Standard** as the print-quality mode; try setting **Vivid Color** as the color correction.
- Make sure that the switch on the side of the Standard Paper/Transparency Tray, or on the High-Capacity Transparency/Label Tray, is set to **Transparency**.
- Make sure that you have selected in a supported printer driver either **Transparency** for the media tray or **Manual Feed Transparency** (for the manual feed slot).

**Print is wrinkled or rippled**

- If your paper is smooth, glossy, or coated, try a different type of paper. Use only supported paper types.
- Use single-sided printing instead of double-sided printing.

## Printing problems

### The printer times out when connected to a parallel port

- Windows users: To change the timeout for transmission retry, refer to the Microsoft Online Help for instructions.

### Part of the image is missing or image is clipped

- For more details on page sizes, print areas, and margins, refer to User Guide. To maximize the image area, you may have to adjust the margins in your application software.
- In your application, check the setting for **Image Size**.
- Make sure you have selected the correct paper size in the printer driver.
- Make sure you have selected Page Setup after changing printers.

### You have problems printing from a specific application

- Get information and tips on printing from specific applications (such as QuarkXPress and PageMaker) from the Tektronix Color Printer web site.

### Fonts print incorrectly in Windows

- If you have downloaded fonts to your printer, or stored additional fonts on the internal hard drive, you may need to reinstall the fonts.
- If you are using PostScript fonts, make sure ATM (Adobe Type Manager) is installed and configured properly. ATM software is shipped with your printer.

### Text prints in Courier font

- The font you have specified is not available. The printer has 136 resident fonts. Other fonts must be set up from the printer driver to print with each job.

## Preventing media jams

Use the following guidelines to prevent media jams inside the printer.

- Make sure the printer is on a flat, level surface.
- Do not overfill the media tray, as indicated by the tray's maximum-capacity label.
- Media:
  - Use only the recommended media. Refer to the printer's user guide, or print the Paper Tips Page from the printer's front panel. See *Internal printer pages* on page 40 for more information.
  - Make sure you use a high-quality paper: 60 - 150 g/m<sup>2</sup> (16 - 40 lb. bond) paper in the media trays. Refer to the printer's user guide for more information.
  - Use only Phaser 850 printer transparencies; they have been specially formulated for this printer.
  - Keep paper and other supplies clean and free from dust.
  - Paper that has been sitting out of its sealed wrapper can become distorted, causing paper jams. Keep paper sealed until you are ready to use it for printing.
  - Do not use paper that has been creased or wrinkled.
  - Do not print on sheets of labels that are missing labels.
  - Use only Phaser 850 printer labels.
  - Do not use perforated paper, or odd-sized paper.
  - For three-holed paper, make sure margins are adjusted to avoid printing over the holes.
- When using the manual feed slot:
  - Always use two hands to load the media straight and evenly.
  - Wait until a front panel message prompts you before feeding a second sheet of paper or transparency.
- Clean the printer's rollers if they are visibly dirty. Refer to *page 54* for more information.
- In high-humidity conditions, or when using speciality papers that can be printed on both sides: Remove the paper from the paper tray, turn over the stack of paper, and reinsert the paper into the tray.
- At the printer's front panel:
  - a. Scroll to **Help**, press **Select**.
  - b. Scroll to **Jams**, press **Select**.
  - c. Scroll to **Preventing Media Jams**, press **Select**.
  - d. Review the Paper Tips Page.

After you clear a media jam, the printer automatically outputs a second, usually partial print to remove any image that may remain on the print drum; then the printer prints your original image.

The lower tray is the default tray for paper that the printer uses in self-cleaning. If you have one or two High-Capacity Paper Tray Assemblies, you can make the upper or middle tray the default tray through the printer's front panel menu. Refer to *Selecting the source for cleaning pages* on page 54 for instructions.

## Turning the Startup Page on or off

By default, the printer produces a Startup Page each time the printer is turned on or reset. If desired, you can disable the Startup Page. There are three methods for turning on/turning off the Startup Page:

### From the printer's front panel

1. Scroll to **Menu**; press **Select**.
2. Scroll to **Printer Configuration**; press **Select**.
3. Scroll to **Default Printer Settings**; press **Select**.
4. Scroll to **Startup Page**; press **Select** to toggle the setting.
5. Scroll to **Exit**; press **Select**.

### From PhaserLink Printer Management software

Refer to the *PhaserShare Networking Manual* for information on using your World Wide Web browser to access the printer via a TCP/IP network connection.

### From utility files

Download one of the following files from the printer's CD-ROM:

- **Macintosh:** Use the Apple Printer Utility (refer to *page 27* for instructions).
- **PC:** Use utility files *STARTPG.PS* (to turn on the Startup Page), *NOSTRTPG.PS* (to turn off the Startup Page); refer to *page 23* for downloading instructions.

## Protected mode for the front panel menu

System administrators can control user access to the front panel menus with PhaserLink Software or the following utility files (refer to *page 23* for instructions on downloading utility files):

### Macintosh utility files

- *Menu Short* (limits menu access)
- *Menu Long* (expands menus)

### PC utility files

- *MENUSHRT.PS* (limits menu access)
- *MENULONG.PS* (expands menus)

The “short” utility files limit the menu items displayed on the front panel, preventing users from changing front panel settings that may affect the prints of other users. Users instead select printing features — such as color corrections — through their applications only. In the protected mode, users can access all menus except the **Default Printer Settings**, **Advanced Printer Settings**, and **Network Settings**.

The “long” utility files reset the front panel to display full menus and allow full access to the settings.

If you used the *Menu Short* or *MENUSHRT.PS* files to limit the front panel menus, you can temporarily restore the full menus:

1. When the **Ready to Print** message appears, scroll to **Menu**; press **Select**.
2. Scroll to **Printer Configuration**; press **Select**.
3. Hold down the left arrow and press **Select**. The **Default Printer Settings** and **Network Settings** selections are added to the menu and are removed again when the **Printer Configuration** menu is closed.

## Turning Sys/Start Job execution on or off

You may load a startup (*Sys/Start*) file onto the printer's internal hard disk, if installed. The *Sys/Start* job file is similar to an *init* file: When you turn on the printer, the file executes — providing that *Sys/Start* has been turned on either through a front panel setting or with a control file downloaded to the printer.

If the *Sys/Start* file contains an error, the printer ignores the remainder of the file and may not start up as expected.

### Using the front panel

1. When the **Ready to Print** message is displayed, use the down arrow to scroll to **Menu**; press the **Select** button.
2. Scroll to **Printer Configuration**; press **Select**.
3. Scroll to **Default Printer Settings**; press **Select**.
4. Scroll to **Advanced Printer Settings**; press **Select**.
5. Scroll to **Sys/Start Job**. Press **Select** to change the setting to **On**.
6. To save the new setting, scroll to **Exit**; press **Select**. The **Ready to Print** message appears.
7. To make the change take affect, turn the printer off and back on again.

### Using utility files

Refer to *page 23* for instructions on downloading utility files. To make the change take affect, turn the printer off and back on again.

#### Macintosh utility files

- *Set SysStart Job* (Turns on automatic execution of the SysStart job.)
- *No SysStart Job* (Turns off automatic execution of the SysStart job.)

#### PC utility files

- *SYSTART.PS* (Turns on automatic execution of the SysStart job.)
- *NOSYSTRT.PS* (Turns off automatic execution of the SysStart job.)

# Cleaning Phaser 850 Printers

You need to clean the printer when prints are striped or smeared. How often you need to clean the printer will depend on how heavily the printer is used and the environment in which it is used.

## Selecting the source for cleaning pages

The lower tray is the default source for the cleaning pages that the printer uses in its cleaning procedures. When one or two High-Capacity Paper Tray Assemblies are installed, you can ensure that the printer always uses paper from the lower or middle paper tray in its self-cleaning procedures by changing a setting in the printer's front panel:

1. When the **Ready to Print** message is displayed, scroll to **Menu** and press **Select**.
2. Scroll to **Printer Configuration**; press **Select**.
3. Scroll to **Default Printer Settings**; press **Select**.
4. Scroll to **Advanced Printer Settings**; press **Select**.
5. Scroll to **Cleaning Page Source**; press **Select** and choose the desired tray.
6. To return the printer to the **Ready to Print** message, scroll to **Exit**; press **Select**.

You can also change the default through PhaserLink Printer Management software if your printer is connected to a network via TCP/IP. Simply enter your printer's IP address in a standard web browser. Refer to the *PhaserShare Networking Manual* for details.

## Cleaning supplies

Optional cleaning kits contain presoaked alcohol wipes; order number: 016-1845-00.

If you purchase isopropyl alcohol, always use alcohol that is at least 90% pure; alcohol that has additives can damage the printer.

### **Warning**

Alcohol is flammable; keep alcohol-soaked wipes and swabs away from hot surfaces.

## Light stripes on prints

If prints have narrow, lengthwise stripes that are faded or the wrong color, or prints have missing colors, run the automatic printhead-cleaning sequence from the printer's front panel.

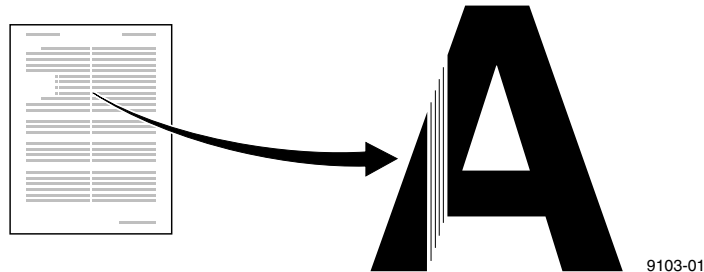

1. When the **Ready to Print** message appears, scroll to **Menu**; press **Select**.
2. Scroll to **Troubleshooting**; press **Select**.
3. Scroll to **Eliminate Light Stripes**; press **Select**.
  - A series of front panel messages indicate the condition of the printer as it progresses through a sequence of automatic cleaning routines. The printer outputs a test page at the end of the cleaning sequence you can use to confirm the success of the procedure.

4. Examine the test page, checking for any missing color bars. The following illustration shows a correct Test Page with black (1), cyan (2), magenta (3), and yellow (4). Also shown is an example of a Test Page with a missing color bar in the magenta.

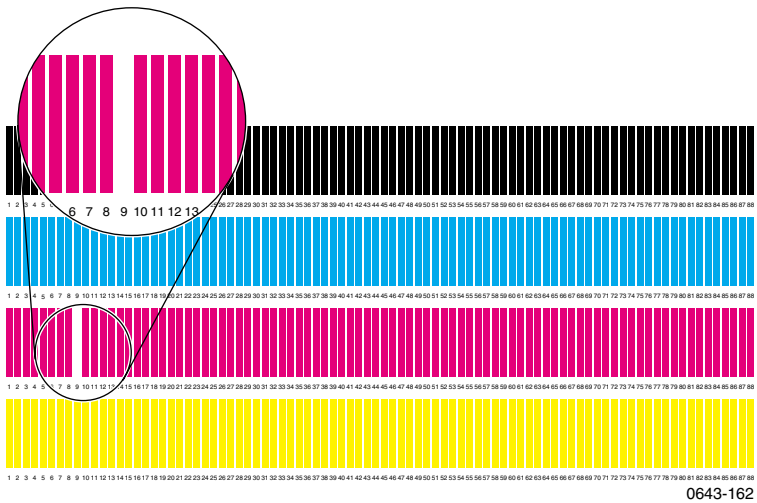
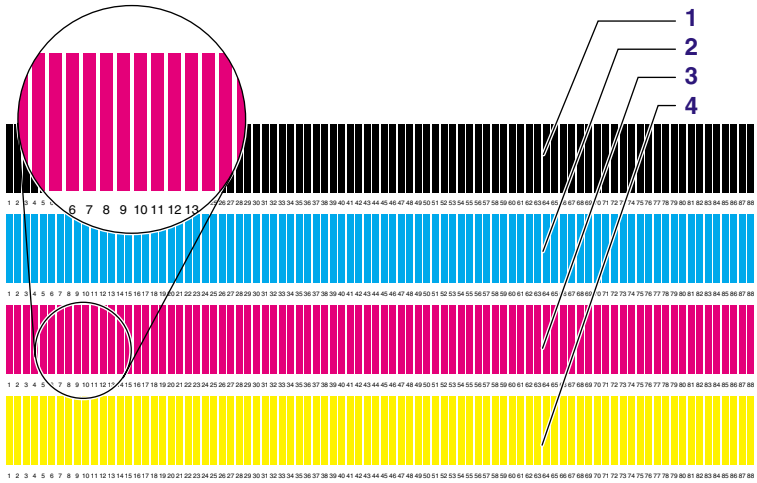

5. If one or more of the color bars are still missing or are light, repeat the cleaning sequence.

**Note**

The second cleaning sequence implements a more extensive cleaning of the printer, which may take longer for the printer to execute than the previous cleaning.

6. Return the printer to normal operation by scrolling to **Exit** and pressing **Select**. The **Ready to Print** message appears when the printer is returned to normal operation.
7. If your prints still have color stripe problems after the third cleaning sequence, turn off the printer for at least 4 hours to allow the ink to solidify. When the printer is turned back on, it performs a self-cleaning routine that may resolve the problem.
8. If the problems persist, perform two more **Eliminate Light Stripes** cleaning procedures.
9. If your prints still have color stripe problems, service may be required.

## Cleaning for oily streaks

If your prints show oily streaks, you can clean the wiper blade that is located inside the maintenance drawer (A).

1. Open the front cover and remove the maintenance drawer (A).

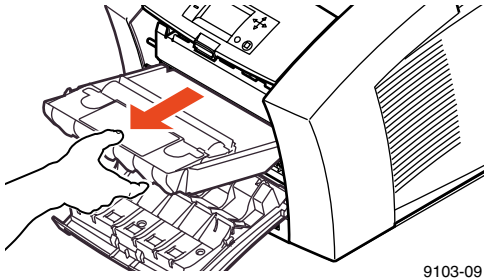

2. Use a lint-free wipe to gently wipe any excess debris from the clear plastic wiper blade.

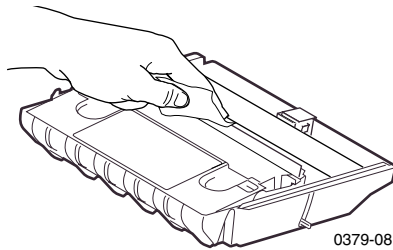

3. Reinsert the maintenance drawer into the printer.

## Cleaning for ink smears: internal paper path

Clean the printer's internal paper path surfaces if your prints have stray ink marks on the front or the back.

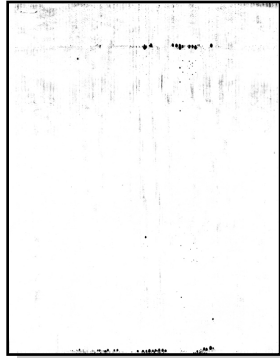

9103-06

### Caution

Always use clean sheets of paper to clean the paper path. Do not reuse cleaning sheets. High-grade, heavier papers, such as 120 g/m<sup>2</sup> (32 lb.) bond, work best.

1. Load high-grade paper into the printer and make sure that the tray's media selector switch is set to **Paper**. If your printer is configured with just the upper media tray, load that tray and set the media selection switch to **Paper**. If you have installed one or two High-Capacity Paper Tray Assemblies, load either the upper tray or the lower tray. The lower tray is the default; if you use the upper or middle paper tray, make sure that the printer's default has been set. Refer to *Selecting the source for cleaning pages* on page 54 for details.
2. When the printer is on and the **Ready to Print** message appears in the front panel, scroll to **Menu**; press **Select**.
3. Scroll to **Troubleshooting**; press **Select**.
4. Scroll to **Remove Ink Smears**; press **Select**.

5. After a short delay during the warm-up period, the printer begins an automatic sequence of feeding several clean sheets of paper from the media tray selected as the cleaning page source.
6. When the cleaning sequence is complete, inspect the last sheet of paper fed through the printer. If the printer is not clean, repeat the cleaning sequence.
7. Scroll to **Exit**; press **Select**. After a warm-up cycle, the printer returns to normal operation.

**Note**

If the cleaning procedure is cancelled early, there may be a delay before the printer is ready to perform two-sided printing.

**If the ink smear problem persists:**

Refer to the following two procedures for directions on cleaning paper-feed rollers and the paper-exit path.

## Cleaning for ink smears: paper-feed rollers

The paper-feed rollers carry the print media from the media tray and manual feed slot through the printer. Occasionally, stray ink particles become attached to the paper-feed rollers, creating slick roller surfaces that cause media to feed improperly. If ink smear problems persist after you have performed the “*Cleaning for ink smears: internal paper path*” procedure, then clean the paper-feed rollers.

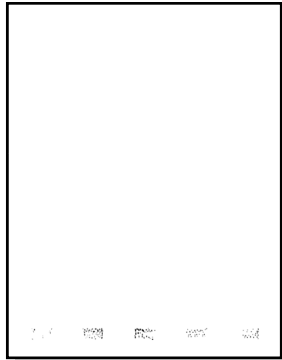

9103-07

### Caution

Hot surfaces exist behind the middle paper-feed rollers. To avoid personal injury during cleaning procedures, do not reach in behind these rollers.

1. Open the front cover.

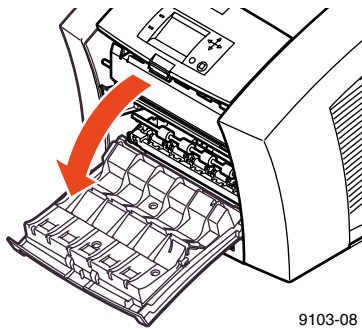

9103-08

2. Remove the maintenance drawer (A) from the printer.

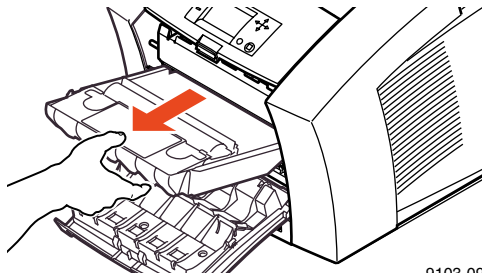

9103-09

- 3.** The upper paper-feed rollers are located above the slot for the maintenance drawer (A). To clean these rollers:
  - a.** Use a prepackaged alcohol-soaked wipe, or use a lint-free cloth with 90-percent isopropyl alcohol.
  - b.** Place the cleaning wipe against each upper rubber roller, pressing to create pressure against the roller.
  - c.** Use the blue thumbwheel to turn the upper rollers. The upper rubber rollers should rotate *four or five complete revolutions* for each roller segment to ensure proper cleaning. Scrub each roller thoroughly. If the wipe becomes dirty, discard it and use another.

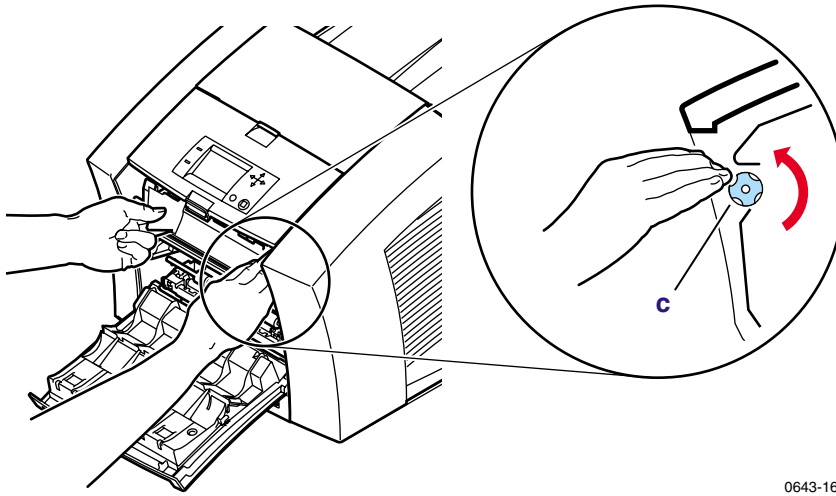

0643-163

- 4.** To clean the middle rubber feed roller behind the shiny metal plate:
  - a.** Use a prepackaged alcohol-soaked wipe, or use a lint-free cloth with 90-percent isopropyl alcohol. Place the wipe against the underside of each middle roller.
  - b.** Manually rotate the middle roller.

- c. **Scrub each roller thoroughly.** If the wipe becomes dirty, discard it and use another.

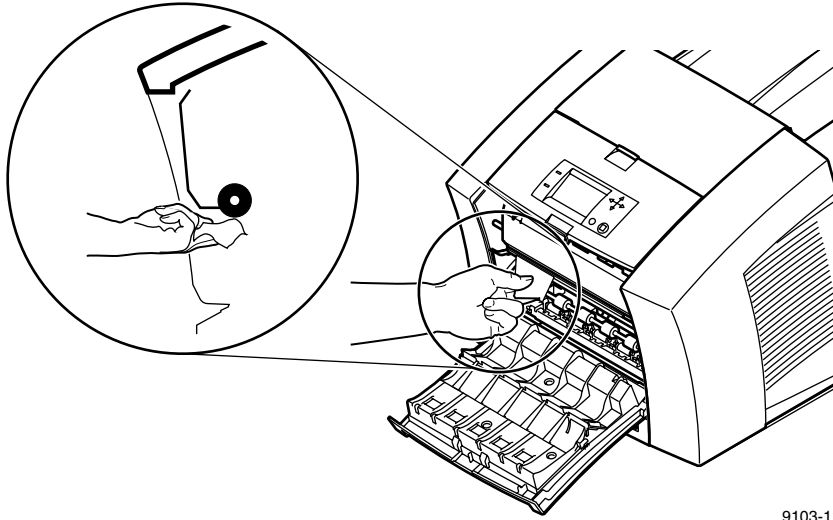

9103-11

- 5. The lower paper-feed rollers are located below the maintenance drawer (A): one set of rollers is black rubber; the other set is white plastic. To clean the lower rollers:
  - a. Use a prepackaged alcohol-soaked wipe, or use a lint-free cloth with 90-percent isopropyl alcohol. Place and hold the cleaning wipe on top of the white and black rollers.
  - b. Use the blue thumbwheel to turn the rollers. Rotate the rollers *four or five complete revolutions* for each roller segment to ensure proper cleaning.
  - c. **Scrub each roller thoroughly until clean.** If the wipe becomes dirty, discard it and use another.

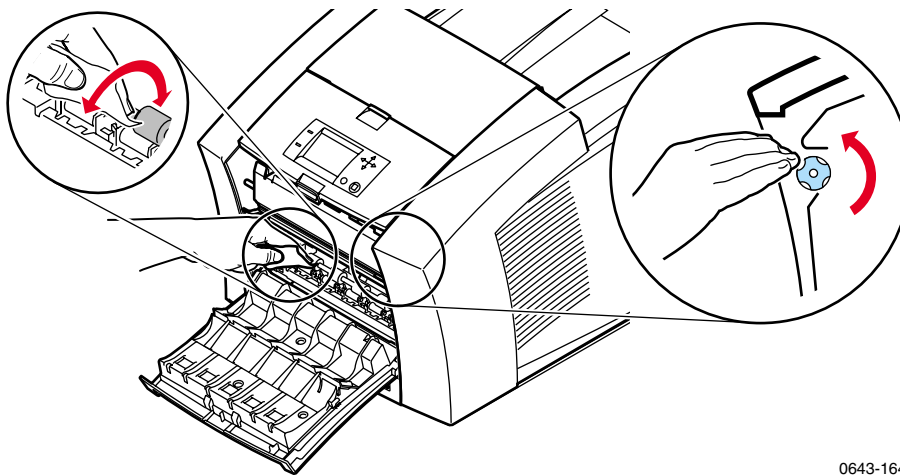

0643-164

*Cleaning Phaser 850 Printers*

6. To clean the shiny metal plate, use a prepackaged alcohol-soaked wipe, or use a lint-free cloth with 90-percent isopropyl alcohol.

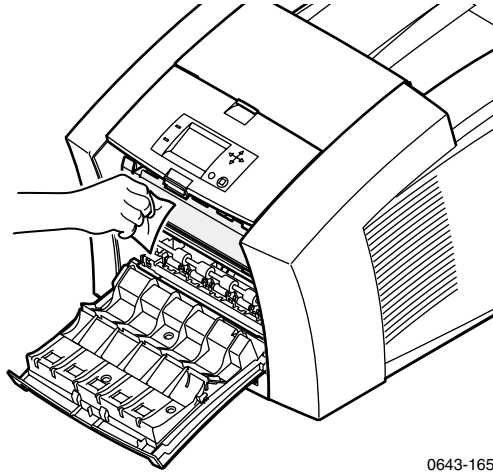

0643-165

7. Put the maintenance drawer (A) back into the printer.
8. Close the front cover.

## Cleaning for ink smears: paper-exit path

If you have already performed the other “Cleaning for ink smears” procedures described earlier in this chapter but problems persist, you should clean the paper-exit path. Refer also to *Cleaning for ink smears: paper-feed rollers* on page 61.

Occasionally, stray ink particles and oil become attached to the Rapid Release Guide, rollers, and guides under the exit cover causing ink streaks or marks on the top edge, front, or back of prints. When this occurs, you must clean these parts using alcohol-soaked wipes.

### Sample ink smear: paper-exit path

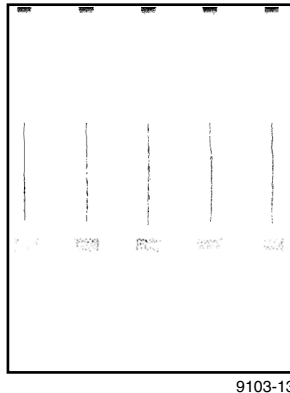

### Caution

To avoid damaging the print drum and Rapid Release Guide, never use any sharp objects in this area, or scrape excess ink with a tool or fingernail.

1. To clean the rubber exit rollers:
  - a. Wrap an alcohol-soaked wipe around the index finger of one hand.
  - b. Press your wipe-covered finger against each roller.

- c. Use the thumbwheel to turn the rollers. Rotate the rollers *four or five complete revolutions* for each roller segment to ensure proper cleaning.

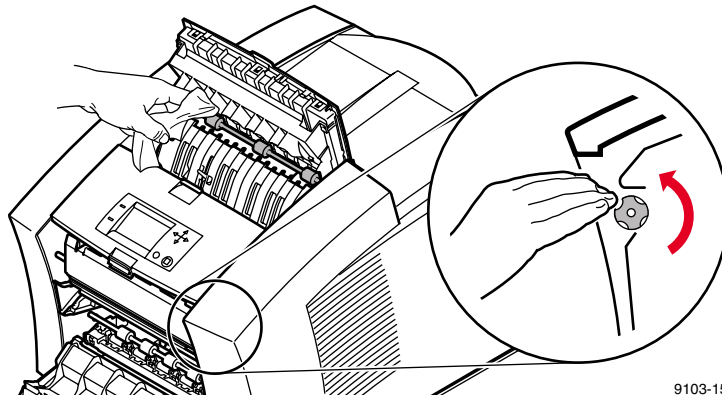

**Note**

You may notice some staining of the exit rollers while performing the cleaning procedure; this is normal and does not indicate additional cleaning is necessary. Simply clean rollers to remove any build-up of ink

2. To clean the two sets of ribbed exit guides under the exit cover, gently wipe the raised ribs using an alcohol-soaked wipe.

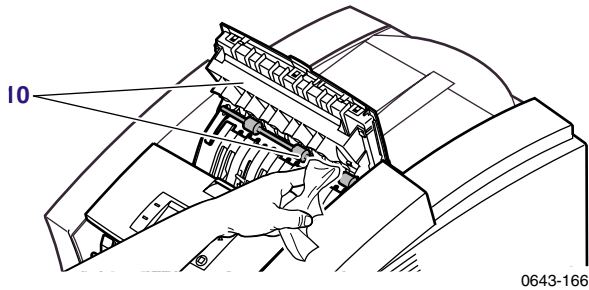

3. Lift the blue paper guide.

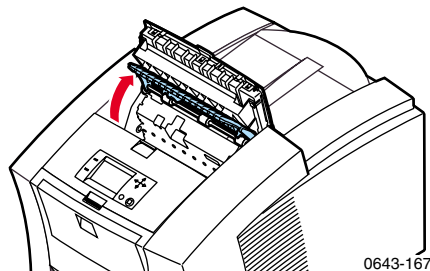

4. Handle the Rapid Release Guide carefully to avoid bending or damaging the clear plastic edge. Lift up on the blue tabs and remove the Rapid Release Guide. Do not use any sharp objects in this area of the printer.

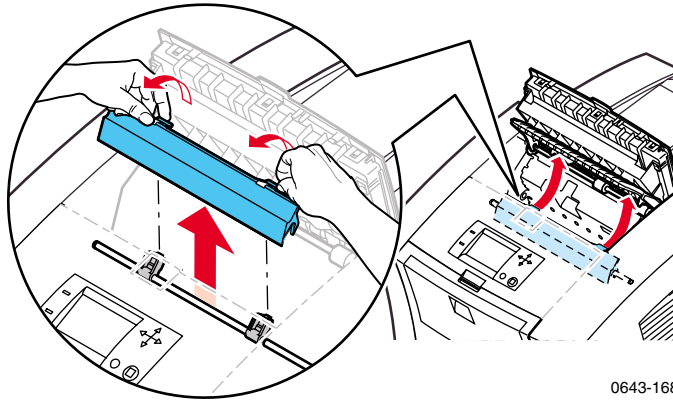

5. Gently wipe the clear plastic Rapid Release Guide with a pre-soaked alcohol cloth.

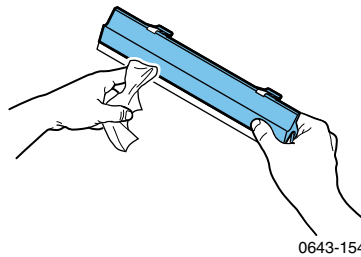

6. If the Rapid Release Guide is damaged, replace it.
7. Reinstall the Rapid Release Guide, pressing down on the blue tabs to snap the guide into place.

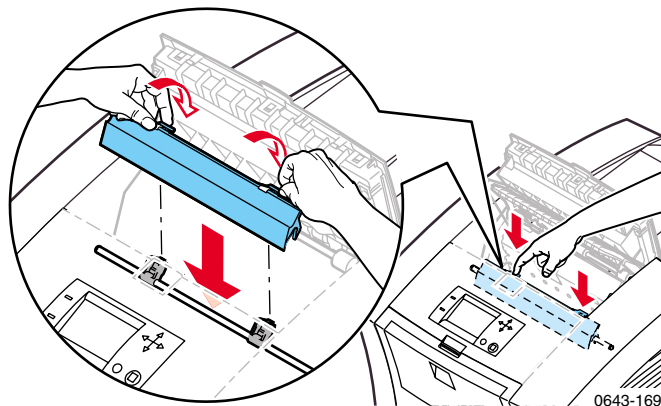

8. Close the exit cover.

## Cleaning for media tray jams

If the printer incorrectly feeds paper or transparencies, or feeds more than one sheet at a time from the media tray, refer to *Preventing media jams* on page 50 before cleaning the printer. If rollers are visibly dirty, perform the following cleaning procedures.

### Cleaning the media-pick roller

1. Remove the media tray from the printer.
2. Open the front cover.

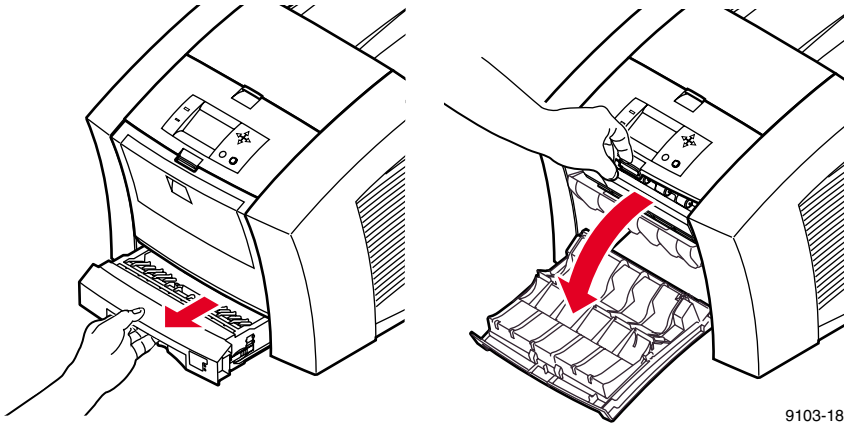

#### Caution

Hot surfaces exist behind the upper paper-feed rollers. To avoid personal injury during cleaning procedures, do not reach in behind the paper-feed rollers.

3. Remove the maintenance drawer (A) from the printer.

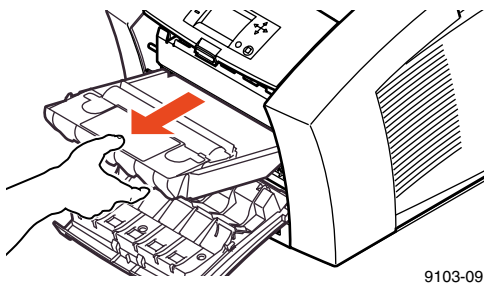

4. To clean the top surface of the media-pick roller:
  - a. Locate the top of the media-pick roller behind the black rubber paper-path rollers.
  - b. Use a prepackaged alcohol-soaked wipe, or use a lint-free cloth with 90-percent isopropyl alcohol.
  - c. **Scrub the top surface of the media-pick roller thoroughly.** If the wipe becomes dirty, discard it and use another.

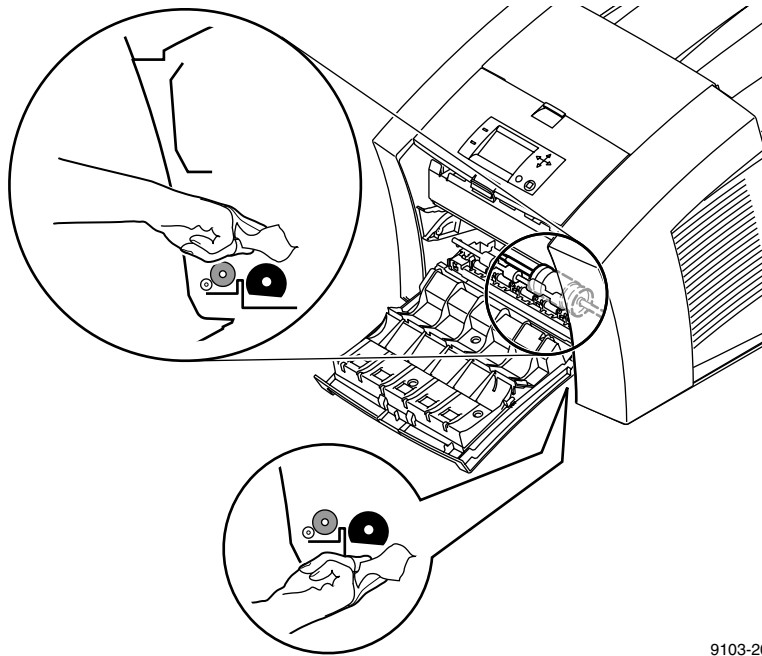

9103-20

5. Replace the maintenance drawer (A) in the printer.
6. Close the front cover.

7. To clean the bottom of the media-pick roller:
  - a. Use a prepackaged alcohol-soaked wipe, or use a lint-free cloth with 90-percent isopropyl alcohol.
  - b. To access the pick roller, reach into the media tray slot. **Scrub the bottom surface of the pick roller thoroughly.**

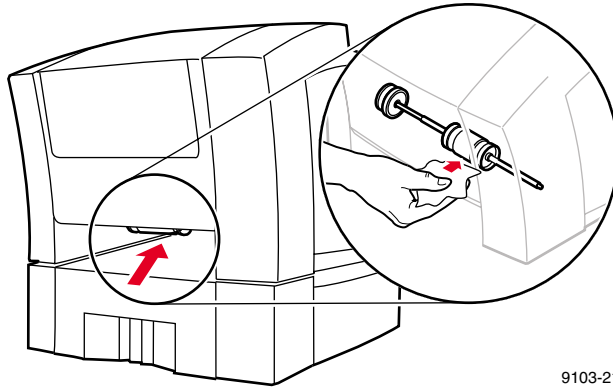

9103-21

8. Replace the upper media tray in the printer.

## Cleaning the separator pad

1. Remove the upper media tray from the printer.
2. Gently wipe the separator pad using an alcohol-soaked cloth.

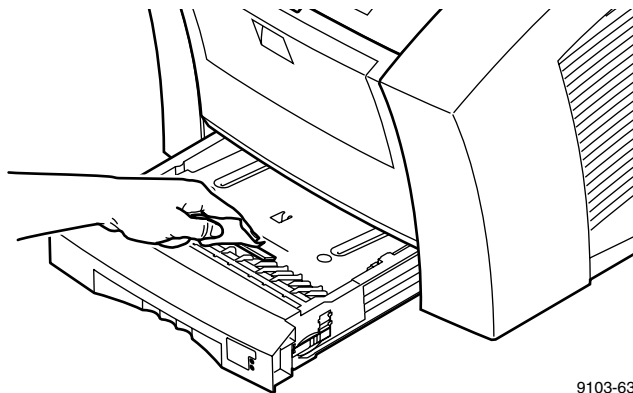

9103-63

3. Inspect the separator pad for damage to the metal edge; it should be free of dents and lie flat against the rubber surface. If any damage is seen, the separator pad should be replaced (part number: 116-0838-00).
4. Replace the upper media tray in the printer.

## Cleaning for lower tray jams: paper-feed rollers

If the printer feeds paper incorrectly or feeds more than one sheet at a time from the High-Capacity Paper Tray Assembly, refer to *Preventing media jams* on page 50 before cleaning the printer. If rollers are visibly dirty, perform the following cleaning procedures.

1. Remove the paper tray from the High-Capacity Paper Tray Assembly. If your printer has two assemblies, remove the tray from each one. The two paper-feed rollers for each assembly are visible when each tray is removed.
2. Using an alcohol-soaked cloth, **scrub the rollers thoroughly**. Rotate the roller several times to ensure proper cleaning.

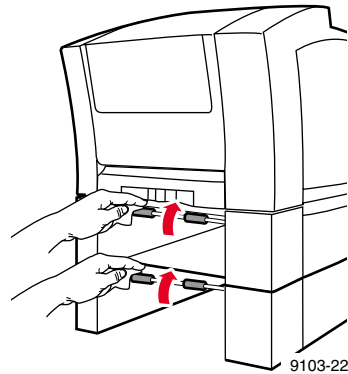

3. Replace the paper tray in the High-Capacity Paper Tray Assembly.



# Regulatory Information for Phaser 850 Printers

## Canadian EMC (Electromagnetic Compatibility) regulatory standards

- This digital apparatus does not exceed the Class B limits for radio noise emissions from digital apparatus set out in the Radio Interference Regulations of the Canadian Department of Communications.
- Le présent appareil numérique n'émet pas de bruits radioélectriques dépassant les limites applicables aux appareils numériques de la classe B prescrites dans le Règlement sur le brouillage radioélectrique édicté par le ministère des Communications du Canada.

## Declaration of conformity

Tektronix, Inc.  
Color Printing and Imaging Division  
P.O. Box 1000  
Wilsonville, Oregon 97070-1000 U.S.A.

declares, under our sole responsibility, that the products

Phaser 850 printer (Z850)

to which this declaration relates, is in conformity with the following standard(s) or other normative document(s):

For the EC EN60950:1992	Safety of Information Technology Equipment including Electrical Business Equipment
For the EC EN55022:1992	Limits and methods of measurement of radio Interference characteristics of Information Technology Equipment
For the EC EN50082-1:1997	The Generic Immunity Standard Residential, Commercial, and Light Industry.

<b>Environmental Phenomena</b>	<b>Basic Standard</b>
Radio-Frequency Electromagnetic Field immunity	EN 61000-4-3: 1995-02
Electrostatic Discharge	EN 61000-4-2: 1995-01
Fast Burst Transient	EN 61000-4-4: 1995-01
Line Surge	EN 61000-4-5: 1995-02
Radio-Frequency Conducted Immunity	EN 61000-4-6: 1996-03
Voltage Dips and Interruptions	EN 61000-4-11: 1994-06
Flicker	EN 61000-3-3: 1994-12

following the provision of the  
Low Voltage Directive 73/23/EEC, the Electromagnetic Compatibility Directive  
89/336/EEC, Machinery Directive 89/392/EEC.

## FCC Class B device

The equipment described in this manual generates and uses radio frequency energy. If it is not installed and used properly in strict accordance with Tektronix' instructions, it may cause interference with radio and television reception.

This equipment has been tested and verified to comply with the limits for a Class B digital device, pursuant to Part 15 of the FCC Rules. These limits are designed to provide reasonable protection against harmful interferences in a residential installation. This equipment generates, uses and can radiate radio frequency energy and, if not installed and used in accordance with the instructions, may cause harmful interference to radio communications. However, there is no guarantee that interference will not occur in a particular installation. If this equipment does cause harmful interference to radio or television reception, which can be determined by turning the equipment off and on, the user is encouraged to try to correct the interference by one of more of the following measures:

- Reorient or relocate the receiving antenna.
- Increase the separation between the equipment and receiver.
- Connect the equipment into an outlet on a circuit different from that to which the receiver is connected.
- Consult the dealer or an experienced radio/TV technician for help.

### **Warning**

Changes or modifications not expressly approved by Tektronix can affect emission compliance and could void the user's authority to operate this product. To ensure emission compliance, use shielded interface cables.

# Phaser 850 Printer Material Safety Data Sheets

Proper management of environmental resources protects the well-being of our employees, customers, shareholders, and the communities we are a part of worldwide.

Tektronix establishes and maintains sound environmental management practices to accomplish this goal and to assure compliance with the laws, regulations, and orders of the responsible governmental authorities wherever Tektronix and its subsidiaries operate.

Tektronix, Incorporated is complying with government regulations by providing Material Safety Data Sheets for this product.

Color Printing and Imaging Division  
Tektronix, Incorporated

## MSDS for Silicone Oil

### SECTION 1 - PRODUCT IDENTIFICATION

Trade Name: Tektronix Silicone Intermediate Transfer Layer Fluid, impregnated into printer's maintenance roller.

Tektronix Part Number: 016-1822-00 (replacement standard maintenance kit)

Tektronix Part Number: 016-1834-00 (replacement extended maintenance kit)

Product Use: Tektronix Phaser® 850 color printers

### SECTION 2 - INFORMATION ON INGREDIENTS

Tektronix Silicone Intermediate Transfer Layer Fluid is a proprietary blend of silicone oils. Specific identities of components, and their percentage composition, are withheld as a trade secret.

### SECTION 3 - HAZARDS IDENTIFICATION

ROUTES OF EXPOSURE: Skin, eyes

POTENTIAL HEALTH EFFECTS: Health effects from this product are expected to be negligible, when product is used as intended.

Immediate Effects:

Inhalation: Not an expected route of entry

Skin: May cause mild irritation.

Eyes: May cause mild irritation.

Ingestion: Not an expected route of exposure.

Chronic Effects: None known or expected.

#### SIGNS AND SYMPTOMS OF EXPOSURE

Mild skin or eye irritation.

#### MEDICAL CONDITIONS AGGRAVATED BY EXPOSURE

None known.

### SECTION 4 - FIRST AID MEASURES

INHALATION: Not a route of exposure for this product.

EYES: Flush thoroughly with water. Seek medical attention if symptoms occur.

SKIN: Wash thoroughly with soap and water. Seek medical attention if symptoms of irritation occur.

INGESTION: Not a route of exposure for this product.

### SECTION 5 - FIRE FIGHTING MEASURES

FLASH POINT: Flash point of fluid is 226 degrees C, Pensky-Martens closed-cup tester.

EXTINGUISHING MEDIA: All extinguishing agents classified as B and C are effective, including dry powder(s), CO<sub>2</sub>, and halon.

FIRE FIGHTING INSTRUCTIONS: As for any fire, wear self-contained breathing apparatus, pressure demand, MSHA/NIOSH approved, and protective gear.

FIRE AND EXPLOSION HAZARDS. During a fire, irritating and toxic substances may be generated by thermal decomposition or combustion. No unusual fire hazards expected.

### SECTION 6 - ACCIDENTAL RELEASE MEASURES

SPILL OR LEAK: Fluid is impregnated into maintenance roller. Small amounts (i.e., drops) may result from normal handling. Absorb and place in an appropriate disposal container. Clean spills thoroughly because residue can be slippery.

### SECTION 7 - HANDLING AND STORAGE

HANDLING: Wash hands with soap and water after contact. Clean spills per SECTION 6.

STORAGE: No special requirements.

### SECTION 8 - EXPOSURE CONTROL - PERSONAL PROTECTION

No special protection indicated when used as intended.

### SECTION 9 - PHYSICAL AND CHEMICAL PROPERTIES

APPEARANCE: Clear liquid impregnated into maintenance roller.

ODOR: Mild

SOLUBILITY IN WATER: No data

SPECIFIC GRAVITY: Specific gravity of fluid is 0.97 (water=1)

**SECTION 10 - STABILITY AND REACTIVITY**

STABILITY: Stable.

INCOMPATIBILITY WITH OTHER MATERIALS: Strong oxidizing agents

HAZARDOUS DECOMPOSITION PRODUCTS: At elevated temperatures, formaldehyde may be generated.

HAZARDOUS POLYMERIZATION: Will not occur.

**SECTION 11 - TOXICOLOGICAL INFORMATION**

No toxicology data on mixture.

**SECTION 12 - ECOLOGICAL INFORMATION**

Not available.

**SECTION 13 - DISPOSAL CONSIDERATIONS**

Fluid is not listed as RCRA hazardous waste. Dispose of in accordance with federal, state, and local regulations.

**SECTION 14 - TRANSPORT INFORMATION**

DOT: Not regulated.

**SECTION 15 - REGULATORY INFORMATION**

The following information pertains to the ingredients of Tektronix Silicone Intermediate Transfer Layer Fluid:

TSCA (Toxic Substances Control Act): Listed in the TSCA inventory as verified by our suppliers.

California Proposition 65: Not regulated.

SARA (Superfund Amendment and Reauthorization Acts): Not listed in SARA Section 313. Not listed as SARA Extremely Hazardous Substance.

RCRA (Resource Conservation and Recovery Act): Not listed as RCRA hazardous wastes.

The ingredients of this fluid are not listed as carcinogenic by OSHA, IARC or NTP.

**SECTION 16 - OTHER INFORMATION**

Original preparation date: September 17, 1999.

Prepared by CPID Environmental, Health, and Safety/JMP

Tektronix, Incorporated

P.O. Box 500

Chemical Documentation

Mail Stop 46-825

Beaverton, Oregon 97077

Printer information: 1-800-835-6100

MSDS information: (503) 685-2758

## MSDS for Ink Sticks

### SECTION 1 - PRODUCT IDENTIFICATION

Trade Name:	Tektronix Part Number:
ColorStix® Ink, Black	016-1831-00, 016-1831-50
ColorStix® Ink, Cyan	016-1825-00, 016-1828-00
ColorStix® Ink, Magenta	016-1826-00, 016-1829-00
ColorStix® Ink, Yellow	016-1827-00, 016-1830-00
Four color "rainbow" pack	016-1833-00

Product Use: Tektronix Phaser® 850 Color Printer

### SECTION 2 - INFORMATION ON INGREDIENTS

#### Ingredients

Fatty amide waxes  
Rosin ester  
Phthalate ester  
Black, cyan, magenta, or yellow dye

The specific identity of ingredients, and their percentage composition, are withheld as a trade secret. Tektronix ColorStix® solid-ink sticks are considered articles under US OSHA Hazard Communication Standard, 29CFR1910.1200. This Material Safety Data Sheet is provided as a customer service.

### SECTION 3 - HAZARDS IDENTIFICATION

ROUTES OF EXPOSURE: Skin

POTENTIAL HEALTH EFFECTS

Immediate effects: None are known or expected. See Section 11 for toxicology test information.

Long term effects: None are known or expected.

Carcinogenicity: None of the ingredients of this product are listed as carcinogens by IARC, NTP, or OSHA.

SIGNS AND SYMPTOMS OF EXPOSURE: None expected.

MEDICAL CONDITIONS AGGRAVATED BY EXPOSURE: None expected.

### SECTION 4 - FIRST AID MEASURES

EYE: Contact unlikely. If particles get into eye, flush thoroughly with water.

SKIN: Wash skin thoroughly with soap and water.

INHALATION: Not applicable

INGESTION: Not applicable

### SECTION 5 - FIRE FIGHTING MEASURES

FLASH POINT: Above 200 degrees C (392 degrees F).

EXTINGUISHING MEDIA: All extinguishing agents classified as B and C are effective including dry powder(s), CO<sub>2</sub>, and halon.

FIRE FIGHTING INSTRUCTIONS: As in any fire, wear self-contained breathing apparatus, pressure demand, MSHA/NIOSH approved, and full protective gear.

FIRE & EXPLOSION HAZARDS: These inks will burn. During a fire, irritating and toxic gases may be generated by thermal decomposition or combustion. No unusual fire hazards expected.

### SECTION 6 - ACCIDENTAL RELEASE MEASURES

SPILL OR LEAK: Not applicable.

### SECTION 7 - HANDLING AND STORAGE

HANDLING: No special precautions.

STORAGE: Avoid high temperatures. Keep ink below 70 degrees C (160 degrees F).

### SECTION 8 - EXPOSURE CONTROL - PERSONAL PROTECTION

EXPOSURE GUIDELINES: None established

ENGINEERING CONTROLS/PERSONAL PROTECTION: No special protection indicated when used as intended.

### SECTION 9 - PHYSICAL AND CHEMICAL PROPERTIES

APPEARANCE/ODOR: Waxy solid. Black, blue, red, or yellow in color. Odorless.

SOLUBILITY: Not water-soluble.

SPECIFIC GRAVITY: 0.99

**SECTION 10 - STABILITY AND REACTIVITY**

STABILITY: Stable.

INCOMPATIBILITY WITH OTHER MATERIALS: None.

HAZARDOUS POLYMERIZATION: Will not occur.

**SECTION 11 - TOXICOLOGICAL INFORMATION**

TOXICITY: Not toxic, as determined by standard laboratory tests for acute oral toxicity.

SKIN IRRITATION: Not a primary skin irritant, as determined by standard laboratory tests.

SKIN SENSITIZATION: Not a skin sensitizer, as determined by standard laboratory tests.

CARCINOGENICITY: Components or product not listed as carcinogens by IARC, NTP, or OSHA.

**SECTION 12 - ECOLOGICAL INFORMATION**

No known impact.

**SECTION 13 - DISPOSAL CONSIDERATIONS**

This product is not a hazardous waste as specified in 40CFR 261. TCLP below hazardous waste levels set by EPA. Manage and dispose of waste in accordance with all federal, state, and local regulations.

**SECTION 14 - TRANSPORT INFORMATION**

D.O.T.: Not regulated.

**SECTION 15 - REGULATORY INFORMATION**

TSCA: All components of these inks are listed in the Toxic Substances Control Act inventory as verified by our suppliers.

RCRA (Resource Conservation and Recovery Act): Not a hazardous waste as specified in 40CFR261.

TCLP below hazardous waste levels set by EPA.

CALIFORNIA PROPOSITION 65: Not regulated.

SARA (Superfund Amendment and Reauthorization Act): Not regulated.

**SECTION 16 - OTHER INFORMATION**

Original preparation date: December 1, 1999

Prepared by CPID Environmental, Health, and Safety/JMP

Tektronix, Incorporated

P.O. Box 500

Chemical Documentation

Mail Stop 46-840

Beaverton, Oregon 97077

Printer information: 1-800-835-6100

MSDS information: (503) 685-2758

## MSDS for CleanTex<sup>®</sup> Alcopad

### SECTION 1 – PRODUCT IDENTIFICATION

Trade name: Alcopad Tektronix Part Number: 016-1845-00  
Product identification numbers: 806B, 806C, 806H, 806T, 806Z, 806  
Chemical name and synonyms: Isopropyl Alcohol  
Chemical formula: CH<sub>2</sub>CH(OH)CH<sub>3</sub>  
Emergency telephone numbers: CHEMTREC (Transportation): 1-800-424-9300  
Product Use: Tektronix Phaser<sup>®</sup> 850 Color Printer

### SECTION 2 – INFORMATION ON INGREDIENTS

Component	CAS#	%	OSHA PEL (ppm)	ACGIH TLV (ppm)
Isopropyl alcohol	67-63-0	91.0	400	400
Deionized water	7732-18-5	9.0	NA	NA

### SECTION 3 – HAZARDS IDENTIFICATION

Product is distributed as a single-use, presaturated pad, in which all the liquid is absorbed by the applicator. Isopropyl alcohol is a flammable liquid. Eye contact will cause local irritation and burning sensations with possible injury if not removed promptly. Repeated or prolonged contact with skin may produce irritation and cause dermatitis. Exposure above TLV may cause irritation of respiratory tract and eyes along with headaches, dizziness and CNS effects. May be harmful if swallowed.

Carcinogenicity (OSHA/NTP/IARC/ACGIH): Not Listed.  
Medical Conditions Aggravated by Exposure: Not Listed.

### SECTION 4 – FIRST AID MEASURES

EYE CONTACT: Flush with water for 15 minutes, including under eyelids. Get Medical help.  
SKIN CONTACT: Flush with water.  
INHALATION: Remove to fresh air. Keep at rest. Restore and/or support breathing as needed. Get prompt Medical attention.  
INGESTION: In the unlikely event of ingestion of a wiper, first aid measures should focus on removal of the object and preventing choking. Once removed, keep affected person at rest. Call physician immediately.

### SECTION 5 – FIRE-FIGHTING MEASURES

FLASH POINT (TCC): 56 degrees F  
FLAMMABLE LIMITS (% BY VOLUME): LEL: NA UEL: NA  
AUTOIGNITION TEMPERATURE degrees F (degrees C): NA  
EXTINGUISHING MEDIA: Isopropyl-alcohol fires may be extinguished using carbon dioxide, dry chemical or alcohol foam. Water may be used to cool containers exposed to the fire.  
UNUSUAL FIRE OR EXPLOSION HAZARDS: Isopropyl alcohol may release vapors which may ignite at or above flash point.  
NFPA RATING: HEALTH (1)  
FLAMMABILITY (3)  
REACTIVITY (0)  
Formulation is classified as an OSHA Class IB Flammable Liquid  
NA = Not Available

### SECTION 6 – ACCIDENTAL RELEASE MEASURES

Since the isopropyl-alcohol solution is completely absorbed by the applicator and the amount of isopropyl alcohol per applicator is small, the chance of a significant spill occurring is small. In the event however, that a significant amount of liquid is released, ventilate the area, especially low areas where vapors may collect, and remove all sources of ignition. Cleanup personnel need protection against liquid contact and vapor inhalation.

### SECTION 7 – HANDLING AND STORAGE

Store in a clean, cool, ventilated area away from sources of ignition and oxidizing agents. Handle and store in a manner suitable for an OSHA class IB Flammable Liquid. Electrical services must meet applicable codes. Use non-sparking tools.

### SECTION 8 – EXPOSURE CONTROL – PERSONAL PROTECTION

Provide ventilation to maintain TLV. Use non-sparking tools. Avoid inhalation of vapors, contact with eyes and repeated or prolonged contact with skin. Do not take internally.

**SECTION 9 – PHYSICAL AND CHEMICAL PROPERTIES**

BOILING POINT (80 degrees C) (180 degrees F)  
% VOLATILE BY VOLUME @ 25 degrees C: 100  
VAPOR PRESSURE (mmHg @ 25 degrees C): 33  
EVAPORATION RATE (BUTYL ACETATE-1) >1  
VAPOR DENSITY (AIR = 1): <1  
FORM: liquid  
% SOLUBLE IN WATER @ 25 degrees C: 100  
ODOR: alcohol  
SPECIFIC GRAVITY (G/CC @ 25 degrees C): 0.79  
APPEARANCE OF LIQUID: clear

**SECTION 10 – STABILITY AND REACTIVITY**

STABILITY: Stable  
HAZARDOUS POLYMERIZATION: Will not occur.  
INCOMPATIBILITIES / CONDITIONS TO AVOID: Caustics, amines, alkanolamines, aldehydes, ammonia, strong oxidizing agents and chlorinated compounds.  
HAZARDOUS DECOMPOSITION PRODUCTS: Carbon monoxide

**SECTION 11 – TOXICOLOGICAL INFORMATION**

Not Available  
Section 12 – Ecological Information  
Not Available.

**SECTION 13 – DISPOSAL CONSIDERATIONS**

Follow Federal, State and Local Regulations.

**SECTION 14 – TRANSPORT INFORMATION**

DOT CLASSIFICATION: Not Regulated.  
Proper Shipping Name:  
Hazard Class:  
UN Number:  
Packing Group:  
Hazard Labeling:  
  
IATA / ICAO CLASSIFICATION: Not Regulated.  
Proper Shipping Name:  
Hazard Class:  
UN Number:  
Packing Group:  
Hazard Labeling:  
  
IMDG CLASSIFICATION: Not Regulated.  
Proper Shipping Name:  
Hazard Class:  
IMDG Page #  
Packing Group:  
Flash Point (degrees C):  
Marine Pollutant:

**SECTION 15 – REGULATORY INFORMATION**

SARA TITLE III REPORTING:  
Toxic Chemical (Section 313): Not Listed.  
Extremely Hazardous Substance: Not Listed.  
Section 302, 304, 311, 312)  
  
Hazard Class:  
Chronic Health: Yes  
Acute Health: Yes  
Fire Hazard: Yes  
Pressure Hazard: No  
Reactivity Hazard: No

**TSCA INVENTORY STATUS:** All components listed are on the TSCA inventory.

## **SECTION 16 – OTHER INFORMATION**

The information provided herein is compiled from internal reports and data from professional publications. It is furnished without warranty of any kind, expressed or implied. It is intended solely to assist in evaluating suitability and proper use of the material and in implementing safety precautions and procedures. Employees should use this information as a supplement to other information gathered by them and must make independent determination of suitability and completeness of information from all sources to assure proper use of these materials. All information used must be determined by the user to be in accordance with applicable federal, state and local laws and regulations.

Prepared by:

CleanTex Products  
33 Murray Hill Drive  
Nanuet, NY 10954

June 1997

# Specifications for Phaser 850 Printers

## Temperature

Operating: 10 degrees C to 32 degrees C (50 degrees F to 90 degrees F)

Non-operating: -30 degrees C to +60 degrees C (-22 degrees F to 144 degrees F)

## Humidity

Operating: 10% to 80% relative humidity, non-condensing

Non-operating: 10% to 95% relative humidity, non-condensing

## Altitude

Operating: 0 to 2438 m (0 to 8000 ft.) above sea level

Shipping: 0 to 15000 m (0 to 49200 ft.) above sea level

## Primary voltage ranges

90 - 140 VAC, 110 VAC nominal

180 - 264 VAC, 220 VAC nominal

## Frequency range

47 to 63 Hz

## Primary fusing

125 VAC, 250 VAC, 10 Amps and 6 Amps (Not user-accessible)

## Power Consumption

State	Typical Power	Maximum Allowable
Continuous printing	220 watts per hour	600 watts per hour
Idle	180 watts per hour	300 watts per hour
Standby	130 watts per hour	not applicable
Energy Star (optional)	not applicable	30 watts per hour

## Dimensions of the printer (without a High-Capacity Paper Tray Assembly)

Depth: 600 mm (23.5 in.)

Width: 432 mm (17 in.)

Height: 390 mm (15.3 in.)

## Weight of the printer

36 kg (79 lb.)

### Dimensions of one High-Capacity Paper Tray Assembly

Height: 127 mm (5 in.)  
Depth: 530 mm (20.875 in.)  
Width: 440 mm (17.375 in.)

### Weight of one High-Capacity Paper Tray Assembly

9.1 kg (20 lb.)

### Sound level

Sound Pressure ( $L_{pA}$ ); Sound Power ( $L_{wA}$ )

Printing:  $L_{pA} < 60$  dB (A)  
 $L_{wA} < 7.2$  Bels (A)

Idle:  $L_{pA} < 45$  dB (A)  
 $L_{wA} < 5.6$  Bels (A)

### Printer tilt

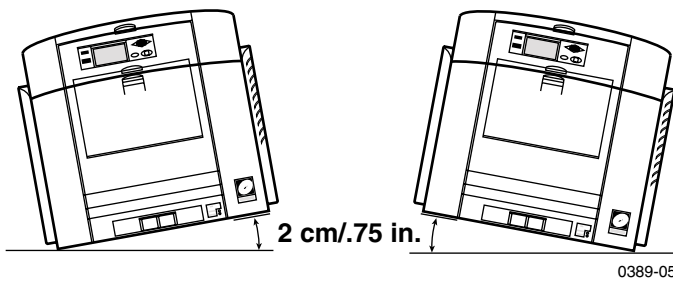

### Printer clearances

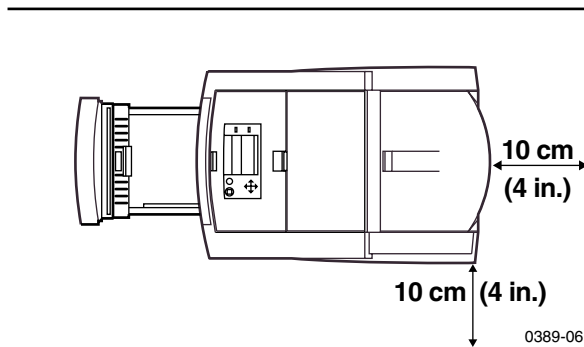

# Index

## Numerics

- 1st Page Preview
  - resetting the timeout 32
  - using 32
  - using with PhaserPrint 20

## A

- adjusting
  - low-resolution images 7
- Adobe Photoshop plug-in 14
- alcohol
  - purity of 54
  - using for cleaning 54
- alcohol wipes MSDS 81
- altitude, operating range 84
- Apple Printer Utility
  - using 27
- automatic tray switching 34

## C

- CD-ROM
  - contents 39
- cleaning
  - Eliminate Light Stripes 55
  - for High-Capacity Paper Tray Assembly jams 72
  - ink smears from internal paper path 59
  - ink smears from paper-exit path 65
  - ink smears from paper-feed problems 61
  - lower pick rollers 72
  - oily streaks 58
  - overview 54
  - precautions using alcohol 54
  - print drum 65
  - supplies, illustrated 54
  - using isopropyl alcohol 54
- cleaning kit
  - contents 54
- cleaning pages
  - changing the media tray source 54
- CMYK Sampler, Macintosh utility file 38
- collating multiple copies 8

- color charts
  - CMYK 36
  - HSB 36
  - PANTONE Color 10
  - printing from a Macintosh 38
  - printing from the front panel 37
  - RGB 36
- Color Connection web site 39

## D

- declaration of conformity 74
- divider pages 9
- downloading files from servers
  - Tektronix ftp server 26
  - World Wide Web 25
- downloading files to the printer
  - Apple Printer Utility 27
  - Macintosh 27
  - PC 29
  - Windows 3.1 29
  - Windows 95 29
- downloading fonts 4
- drum fluid
  - cleaning 65
- duplex
  - troubleshooting 45

## E

- Eliminate Light Stripes
  - cleaning procedure 55
- email notification 40
- enabling and disabling the Startup Page 51
- energy saving mode 34

## F

- Font Sampler, Macintosh utility file 6, 38
- fonts
  - downloading 4
  - Macintosh 5
  - printing a list of resident fonts 6
  - sampler, printing 6
  - TrueType 4
  - Windows 5
- FONTS.PS, PC utility file 6, 38
- frequency range 84

front panel  
 1st Page Preview 32  
 Eliminate Light Stripes 55  
 light intensity 34  
 menus 52  
 messages, troubleshooting 41  
 FTP server  
 accessing 40  
 downloading files from 26

**H**

help pages, printer 40  
 High-Capacity Paper Tray Assembly  
 cleaning the paper-pick rollers 72  
 misfeeds 72  
 paper jams 72  
 HSB Sampler, Macintosh utility file 38

**I**

Image Smoothing 7  
 using with PhaserPrint 20  
 ink smears  
 cleaning internal paper path 59  
 cleaning paper-exit path 65  
 cleaning paper-feed rollers 61  
 ink sticks  
 MSDS 79  
 Intelligent Ready  
 short overview 34  
 internal printer pages 40  
 isopropyl alcohol, see alcohol

**J**

jams, troubleshooting 42  
 job accounting 1  
 job collating 8  
 job information 1  
 job separation pages 9

**L**

labels  
 printing on wrong side 46  
 letterhead paper  
 printing on wrong side 45  
 light stripes  
 full procedure 55  
 lightstripes  
 troubleshooting, full procedure 55  
 low-resolution images, adjusting for 7

**M**

Macintosh utility files 27  
 CMYK Sampler 38  
 Font Sampler 6, 38  
 HSB Sampler 38  
 Menu Long 52  
 Menu Short 52  
 RGB Sampler 38  
 maintenance  
 cleaning the printer 54  
 maintenance drawer  
 wiper blade 58  
 Maintenance Kit  
 MSDS 77  
 Material Safety Data Sheets (MSDS) 76  
 media jams  
 cleaning lower paper-pick rollers 72  
 output after clearing 50  
 preventing 50  
 troubleshooting 42  
 media trays  
 lower tray jams, cleaning for 72  
 Menu Long, Macintosh utility file 52  
 Menu Short, Macintosh utility file 52  
 MENULONG.PS, PC utility file 52  
 MENUHRT.PS, PC utility file 52  
 misfeeds  
 High-Capacity Paper Tray Assembly 72  
 see also media jams  
 MSDS  
 alcohol wipes 81  
 ink sticks 79  
 silicone oil 77  
 multiple copies, collating 8

**O**

oil (printer drum fluid), cleaning 65  
 online services 40

**P**

PANTONE Colors  
 installing printer files 11  
 methods of printing 10  
 printer-specific colors 10  
 printing the color chart from a Macintosh 12  
 printing the color chart from a PC 13  
 selection books 10  
 paper jams, troubleshooting 42  
 paper pick roller cleaning, upper 72

## Index

- PC utility files
    - FONT.SPS 6, 38
    - MENULONG.PS 52
    - MENUSHRT.PS 52
  - PhaserLink Printer Management Software
    - brief description 40
  - PhaserLink Printer Management software 1
  - PhaserPrint plug-in
    - compatibility requirements 14
    - for Photoshop 14
    - installing for Macintosh 14
    - installing for Windows 15
    - selecting options 17
    - starting the plug-in 16
  - Photoshop plug-in 14
  - Plug-in, Adobe Photoshop, using 14
  - power consumption specifications 84
  - previewing a job 32
  - primary fusing 84
  - primary voltage ranges 84
  - print drum, cleaning 65
  - print features
    - automatic tray switching 34
    - collating multiple copies 8
    - controlling through PhaserLink 1
    - previewing 32
  - print log 1
  - print quality problems
    - troubleshooting 49
  - print separation pages 9
  - printed colors, problems with 47
  - printer
    - dimensions 84
    - front panel menus 52
    - internal pages 40
  - Q**
    - Quick Collate option 8
      - using with the 1st Page Preview option 8
  - R**
    - Rapid Release Guide
      - cleaning 67
    - regulatory standards 73
    - RGB Sampler, Macintosh utility file 38
  - S**
    - scaling images
      - using PhaserPrint 21
    - separation pages 9
  - server, FTP, Tektronix
    - downloading files from 26
  - setting
    - front panel intensity 34
  - silicone oil MSDS 77
  - slip sheet 9
  - specifications 84
  - standby mode 34
  - Startup Page
    - enable or disable 51
  - stripes on prints, removing 55
  - Sys/Start Job, enable or disable 53
- T**
- TekSMART Knowledge Base 40
  - Tektronix
    - Color Printer Information Server 26
    - FTP server, downloading files from 26
    - web site 40
  - tray switching 34
  - troubleshooting
    - black and white prints instead of color 47
    - duplex 45
    - Eliminate Light Stripes 55
    - Error ## 44
    - front panel messages 41
    - ink smears 59
    - labels are printed on wrong side 45
    - labels printing on wrong side 46
    - letterhead paper printing on wrong side 45
    - paper jams, preventing 50
    - print quality problems 49
    - printed colors 47
    - tools to help 39
    - two-sided printing 45
  - TrueType fonts 4
  - two-sided printing
    - troubleshooting 45
- U**
- Usage Profile reports
    - brief overview 2
  - utility files
    - Macintosh, using 27
    - PC, using 29
- V**
- voltage ranges 84

**W**

World Wide Web  
  downloading files from 25

**Tektronix®**



Printed on recycled paper