

# Xerox Supplies and Accessories

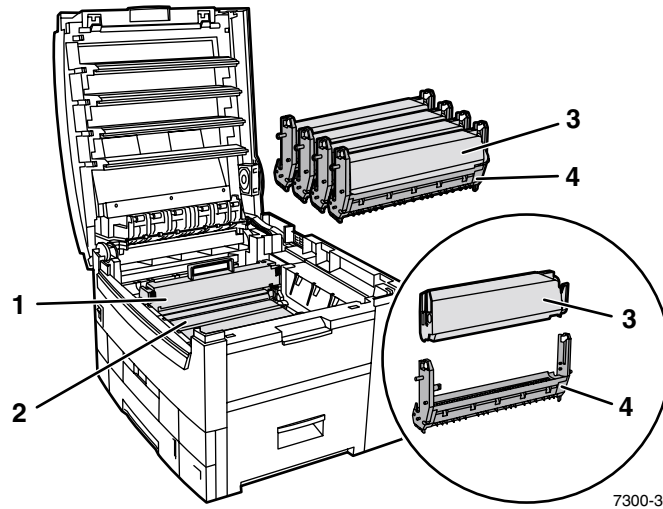

- 1 Fuser
- 2 Transfer Unit
- 3 Toner Cartridge(s)
- 4 Imaging Unit(s)

## Note

Inside the printer, all handles and points of user interaction for replacing Customer-Replaceable Consumables (CRCs) are **light orange**.

When the front panel prompts you that a consumable is low or needs to be replaced, make sure that you have replacements on hand. To order supplies and accessories, contact your local reseller or visit the Xerox web site:

[www.xerox.com/officeprinting/7300supplies](http://www.xerox.com/officeprinting/7300supplies)

## Customer-Replaceable Consumables (CRCs)

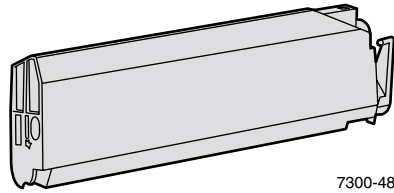

7300-48

### High-Capacity Toner Cartridges

Toner cartridge life expectancy is up to 15,000 images on letter-size paper at 5 percent coverage per color. The following customer usage patterns can significantly reduce toner cartridge life:

- higher than 5 percent coverage
- using paper that is larger than letter-size
- printing jobs of less than 5 pages
- opening and closing the top cover
- turning the printer off and on
- printing in a print-quality mode other than Standard

### Note

Toner life expectancy will be slightly reduced when new imaging units are installed. Subsequent toner cartridges should achieve normal life expectancy.

Item	Part Number
Black	016-1980-00
Cyan	016-1977-00
Magenta	016-1978-00
Yellow	016-1979-00

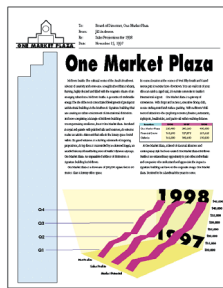

7300-52

This is an example of 5 percent coverage per color (20 percent total coverage).

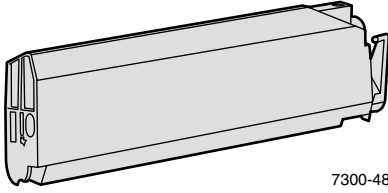

7300-48

**Standard-Capacity Toner Cartridges**

Toner cartridge life expectancy is up to 7,500 images on letter-size paper at 5 percent coverage per color. The following customer usage patterns may significantly reduce toner cartridge life:

- higher than 5 percent coverage
- using paper that is larger than letter-size
- printing jobs of less than 5 pages
- opening and closing the top cover
- turning the printer off and on
- printing in a print-quality mode other than Standard

**Note**

Toner life expectancy will be slightly reduced when new imaging units are installed. Subsequent toner cartridges should achieve normal life expectancy.

Item	Part Number
Black	016-1976-00
Cyan	016-1973-00
Magenta	016-1974-00
Yellow	016-1975-00

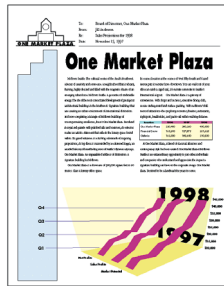

7300-52

This is an example of 5 percent coverage per color (20 percent total coverage).

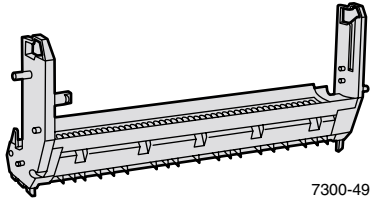

### Imaging Unit

Imaging unit life expectancy is up to 30,000 letter-size pages based on continuous printing. The following customer usage patterns may significantly reduce imaging unit life:

- printing jobs of less than 5 pages
- opening and closing the top cover
- turning the printer off and on
- printing on transparencies or specialty papers
- printing short-edge feed
- printing larger than letter-size print jobs
- automatic two-sided printing
- higher than 5 percent coverage

### Note

Toner life expectancy will be slightly reduced when new imaging units are installed. Subsequent toner cartridges should achieve normal life expectancy.

Item	Part Number
Black Imaging Unit	016-1996-00
Cyan Imaging Unit	016-1993-00
Magenta Imaging Unit	016-1994-00
Yellow Imaging Unit	016-1995-00

### Note

Cyan, Magenta and Yellow imaging units typically need to be replaced at the same time, regardless of color usage, so we offer the following kit.

### Imaging Unit Kit

Item	Part Number
Imaging Unit Kit, Phaser® 7300 (each kit contains a Cyan, Magenta, and Yellow imaging unit)	016-1997-00

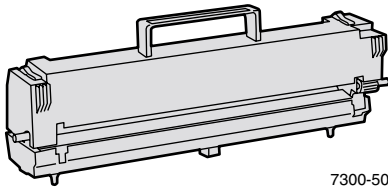

7300-50

**Fuser**

Fuser life expectancy is up to 80,000 letter-size pages. The following customer usage patterns may significantly reduce the transfer unit life:

- printing on transparencies or specialty papers
- printing on certain unsupported papers, especially inkjet papers and inkjet transparencies
- printing larger than letter-size print jobs

Item	Part Number
110 volt	016-1998-00
220 volt	016-1999-00

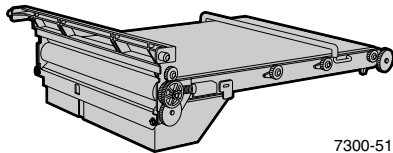

7300-51

**Transfer Unit**

Transfer unit life expectancy is up to 80,000 letter-size pages based on continuous printing. The following customer usage patterns may significantly reduce the transfer unit life:

- printing jobs of less than 5 pages
- opening and closing the top cover
- turning the printer off and on
- printing on transparencies or specialty papers
- printing short-edge feed
- printing larger than letter-size print jobs
- automatic two-sided printing
- higher than 5 percent coverage

Item	Part Number
Transfer Unit	016-2000-00

## Customer-Replaceable Units (CRUs)

### Tray (Paper Cassette Only)

Item	Description	Part Number
Tray 1	<ul style="list-style-type: none"><li>■ 550 sheets of 75 g/m<sup>2</sup> (20 lb. bond) paper</li><li>■ 250 Standard or 200 Premium transparency sheets</li></ul> <p><b>Note:</b> If the automatic duplex unit is installed, it must be removed when replacing Tray 1.</p>	■ 116-1009-00
Trays 2-5	<ul style="list-style-type: none"><li>■ 550 sheets of 75 g/m<sup>2</sup> (20 lb. bond) paper</li></ul>	■ 116-1042-00

## Paper and Media

### Phaser Professional Printing Paper

Item	Size	Description	Part Number
Phaser Premium Color Printing Paper 90 g/m <sup>2</sup> (24 lb. bond)	A/Letter (U.S.) 8.5 x 11 in.	500 sheets	016-1368-00
	A4 (Metric Letter) 210 x 297 mm	500 sheets	016-1369-00
	B 11 x 17 in.	500 sheets	016-1699-00
	A3 297 x 420 mm	500 sheets	016-1700-00
	SRA3 320 x 450 mm	500 sheets	016-1901-00
	Tabloid Extra 12 x 18 in.	500 sheets	016-1900-00
Phaser Glossy Coated Paper 148 g/m <sup>2</sup> (100 lb. book)	A/Letter (U. S.) 8.5 x 11 in.	100 sheets	016-1704-00
	A4 (Metric Letter) 210 x 297 mm	100 sheets	016-1705-00
	11 x 17 in.	50 sheets	016-1718-00
	A3	50 sheets	016-1719-00
	SRA3	50 sheets	016-1941-00
	12 x 18 in.	50 sheets	016-1940-00

### Phaser 35-Series Transparency Film

Item	Size	Description	Part Number
Premium	A/Letter (U. S.) 8.5 x 11 in.	50 sheets	016-1896-00
Premium	A4 (Metric Letter) 210 x 297 mm	50 sheets	016-1897-00
Standard	A/Letter (U. S.) 8.5 x 11 in.	50 sheets	016-1894-00
Standard	A4 (Metric Letter) 210 x 297 mm	50 sheets	016-1895-00

### Phaser Color Laser Labels

Size	Description	Part Number
A/Letter (U. S.) 8.5 x 11 in. (108 lb. label)	100 sheets / 30 labels per sheet (1.0 x 2.625 in. labels)	016-1812-00
A/Letter (U. S.) 8.5 x 11 in. (108 lb. label)	100 sheets / 6 labels per sheet (3.33 x 4.0 in. labels)	016-1813-00
A4 (Metric Letter) 210 x 297 mm (176 g/m <sup>2</sup> )	100 sheets / 14 labels per sheet (38.1 x 99.1 mm labels)	016-1814-00
A4 (Metric Letter) 210 x 297 mm (176 g/m <sup>2</sup> )	100 sheets / 8 labels per sheet (67.7 x 99.1 mm labels)	016-1815-00

**Phaser Premium Cover Paper**

<b>Item</b>	<b>Description</b>	<b>Part Number</b>
A/Letter (U.S.) 8.5 x 11 in. (60 lb., 163 g/m <sup>2</sup> )	100 sheets	016-1823-00
A4 (Metric Letter) 210 x 297 mm (60 lb., 163 g/m <sup>2</sup> )	100 sheets	016-1824-00

**Phaser CD/DVD Labels and Inserts**

<b>Item</b>	<b>Description</b>	<b>Part Number</b>
A/Letter (U.S.) 8.5 x 11 in.	10 sheets / 2 labels per sheet 20 sheets / 1 insert per sheet A/Letter (U.S.) 8.5 x 11 in. cards	016-2011-00
A4 (Metric Letter) 210 x 297 mm	10 sheets / 2 labels per sheet 20 sheets / 1 insert per sheet A4 (Metric Letter) 210 x 297 mm cards	016-2026-00

**Phaser Premium Business Cards**

<b>Item</b>	<b>Description</b>	<b>Part Number</b>
A/Letter (U.S.) 8.5 x 11 in. (70 lb.)	25 sheets / 10 cards per sheet 2.0 x 3.5 in. cards	016-1898-00
A4 (Metric Letter) 210 x 297 mm (190 g/m <sup>2</sup> )	25 sheets / 10 cards per sheet 51 x 89 mm cards	016-1899-00

**Phaser Premium Greeting Cards with Envelopes (Size A7)**

<b>Item</b>	<b>Description</b>	<b>Part Number</b>
A/Letter (U.S.) 8.5 x 11 in. (70 lb.)	25 sheets / envelopes	016-1987-00
A4 (Metric Letter) 210 x 297 mm (190 g/m <sup>2</sup> )	25 sheets / envelopes	016-1988-00

**Cleaning Kit**

<b>Item</b>	<b>Description</b>	<b>Part Number</b>
Cleaning Kit	Contains instructions and five alcohol wipes	016-1845-00



## Accessories

### Internal Hard Drive

Feature	Part Number
<ul style="list-style-type: none"> <li>■ 10 Gbyte capacity</li> <li>■ Adds more storage for downloaded fonts, forms and overlays.</li> <li>■ Provides support for collation, Secure Print, Saved Print, and Proof Print jobs.</li> <li>■ Enables PDF printing.</li> </ul>	7300HD

### Automatic Duplex Unit

Features	Part Number
<ul style="list-style-type: none"> <li>■ Enables automatic 2-sided printing.</li> <li>■ Increased printing versatility and convenience.</li> <li>■ Enables booklet-style printing feature.</li> </ul>	7300DPX

### Additional Memory

Feature	Part Number
■ 64 Mbytes	ZMD64
■ 128 Mbytes	ZMD128
■ 256 Mbytes	ZMD256
■ 512 Mbytes	ZMD512

### 550-Sheet Feeder

Feature	Part Number
<ul style="list-style-type: none"> <li>■ Paper capacity is 550 sheets of 75 g/m<sup>2</sup> (20 lb. bond) paper.</li> <li>■ One or two lower tray assemblies can be installed.</li> </ul>	7300LTA

### 1650-Sheet High-Capacity Feeder

Feature	Part Number
<ul style="list-style-type: none"> <li>■ 3 additional trays</li> <li>■ Paper capacity is 1650 sheets of 75 g/m<sup>2</sup> (20 lb. bond) paper in three trays.</li> <li>■ One lower tray assembly can be added above the lower tray deck for a total paper capacity of 2750 sheets in the trays plus 100 sheets in the Multi-Purpose Tray.</li> </ul>	7300LTD

### Phaser 7300B to 7300N Upgrade Kit

Feature	Part Number
<ul style="list-style-type: none"> <li>■ Adds networking capability and additional memory to 7300B Color Printer base model.</li> <li>■ Enables Enhanced print quality.</li> </ul>	7300FN/A