

*The Xerox
DocuPrint N2125/N2125b
Network Laser Printer*

**System
Administrator
Guide**

Copyright protection claimed includes all forms and matters of copyrightable materials and information now allowed by statutory or judicial law or hereinafter granted, including without limitation, material generated from the software programs which are displayed on the screen such as styles, templates, icons, screen displays, looks, etc.

Printed in the United States of America.

XEROX® and all Xerox product names and product numbers mentioned in this publication are registered trademarks of the Xerox Corporation. Other company trademarks are also acknowledged. PCL is a trademark of the Hewlett-Packard Company. MS, MS-DOS, Windows NT, Microsoft LAN Manager, Windows 95 and Windows 98 are trademarks of Microsoft Corporation. Adobe and PostScript are trademarks of Adobe Systems, Inc. TrueType is a trademark of Apple Computer, Inc. OS/2 is a trademark of International Business Machines Corporation. SunOS and Solaris are trademarks of Sun Corporation.

This printer contains an emulation of the Hewlett Packard PCL 5e and PCL 6 command language (recognizes HP PCL 5e and PCL 6 commands) and processes these commands in a manner compatible with Hewlett Packard LaserJet printer products.

This product includes an implementation of LZW licensed under U.S. Patent 4,558,302.

Changes are periodically made to this document. Technical updates will be included in subsequent editions.

© 2000 by Xerox Corporation. All rights reserved.

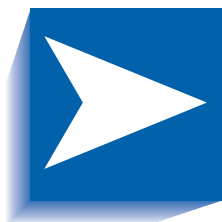

Contents

Safety Notes	<i>i</i>
<i>Note, Caution and Warning Symbols</i>	<i>ii</i>
<i>Electrical Safety</i>	<i>iii</i>
<i>Laser Safety</i>	<i>v</i>
<i>Maintenance Safety</i>	<i>vi</i>
<i>Operational Safety</i>	<i>vii</i>
<i>Ozone Safety</i>	<i>x</i>
Chapter 1 Configuring the Printer	<i>1-1</i>
<i>Using the Control Panel</i>	<i>1-3</i>
<i>The Display</i>	<i>1-4</i>
<i>The Indicator Lights</i>	<i>1-5</i>
<i>The Keys</i>	<i>1-6</i>
<i>Navigating the Menu System</i>	<i>1-8</i>
<i>Menu Symbols</i>	<i>1-9</i>
<i>Setting a Menu Option</i>	<i>1-10</i>
<i>Access to Special Operating Modes</i>	<i>1-12</i>
<i>Control Panel Locks</i>	<i>1-13</i>

<i>Using the Menu System</i>	1-14
<i>Menu System Overview</i>	1-14
<i>Job Menu</i>	1-16
<i>Password Menu</i>	1-19
<i>Tray Menu</i>	1-22
<i>PCL Menu</i>	1-35
<i>System Menu</i>	1-42
<i>Parallel Menu</i>	1-54
<i>Serial Menu</i>	1-58
<i>USB Menu</i>	1-62
<i>Ethernet Menu</i>	1-65
<i>Token Ring Menu</i>	1-79
<i>Novell Menu</i>	1-95
<i>Print Menu</i>	1-103
<i>Reset Menu</i>	1-109
<i>Configuring Automatic Tray Switching</i>	1-114
<i>Tray Sequence Settings</i>	1-116
<i>Paper Handling Exception Conditions</i>	1-117
<i>Tray Sequence Rules</i>	1-120
<i>Tray Sequence Examples</i>	1-122
<i>Paper Size/Type Mismatch</i>	1-124
<i>Configuring Output Offsetting</i>	1-125
<i>Examples</i>	1-127
<i>Configuring Duplex Printing</i>	1-128
<i>Configuring Custom Paper Sizes</i>	1-130
Chapter 2 <i>Managing Printer Usage</i>	2-1
<i>Using CentreWare DP</i>	2-2
<i>CentreWare Internet Services</i>	2-4
<i>Setup</i>	2-5

Chapter 3	<i>Using the Hard Drive and Flash Memory</i>	3-1
	<i>Hard Drive/Flash Memory Considerations</i>	3-2
	<i>Disk Initialization</i>	3-2
	<i>Flash Initialization</i>	3-2
	<i>Downloading Fonts, Forms and Macros (Overlays)</i>	3-3
	<i>FSDOWNLOAD Command</i>	3-4
	<i>FSDELETE Command</i>	3-7
	<i>Using the Hard Drive for Secure and Proof Jobs</i>	3-8
	<i>Creating Secure Jobs</i>	3-8
	<i>Creating Proof Jobs</i>	3-10
	<i>Printing or Deleting Secure or Proof Jobs</i>	3-12
Chapter 4	<i>Maintaining the Printer</i>	4-1
	<i>Regular Printer Maintenance</i>	4-2
	<i>Cleaning the Printer</i>	4-2
	<i>Replacing the Laser Print Cartridge</i>	4-3
	<i>Maintenance Kit Instructions</i>	4-6
	<i>Replacing the Feed Rollers</i>	4-7
	<i>Replacing the Bias Transfer Roller</i>	4-11
	<i>Replacing the Fuser Assembly</i>	4-14
Chapter 5	<i>Troubleshooting</i>	5-1
	<i>Before You Begin Troubleshooting</i>	5-2
	<i>Hardware</i>	5-3
	<i>Software</i>	5-3
	<i>Printer Maintenance</i>	5-3
	<i>Consumables</i>	5-3
	<i>Control Panel Messages</i>	5-4
Chapter 6	<i>Installing Printer Options</i>	6-1
	<i>Optional Equipment</i>	6-3
	<i>550 Sheet Feeder</i>	6-6
	<i>Precautions</i>	6-7

<i>Installing One Feeder</i>	6-8
<i>Installing Two Feeders</i>	6-11
<i>Removing a Feeder</i>	6-14
<i>Envelope Feeder</i>	6-16
<i>Installing</i>	6-16
<i>Removing</i>	6-17
<i>Offset Catch Tray</i>	6-18
<i>Installing</i>	6-18
<i>Removing</i>	6-20
<i>Face Up Bin</i>	6-22
<i>Installing</i>	6-22
<i>Removing</i>	6-24
<i>Duplex Module</i>	6-25
<i>Installing</i>	6-25
<i>Removing</i>	6-27
<i>Hard Disk Drive</i>	6-29
<i>Installing</i>	6-29
<i>Removing</i>	6-32
<i>Interface Card</i>	6-34
<i>Installing</i>	6-34
<i>Removing</i>	6-37
<i>Additional Memory</i>	6-40
<i>Installing or Removing</i>	6-40

Safety Notes

Your printer and the recommended consumable supplies have been designed and tested to meet strict safety requirements. Attention to the following notes will ensure the continued safe operation of your printer.

Note, Caution and Warning Symbols

Throughout this guide, several symbols are used to emphasize useful, important and critical information. They are as follows:



This symbol indicates particularly useful or helpful information about your printer.



This symbol indicates a caution against performing any action that may damage your printer or degrade performance.



This symbol indicates a warning against performing any action that may lead to physical injury.

When used in a step, the above symbols appear smaller but are of equal importance.

Electrical Safety

- Use the power cord supplied with your printer.
- Do not use a ground adapter plug to connect the printer to a power source receptacle that lacks a ground connection terminal.
- Plug the power cord directly into a properly grounded electrical outlet. Do not use an extension cord. If you do not know whether an outlet is grounded, ask an electrician to check the outlet.



You may get a severe electrical shock if you do not connect the grounding conductors correctly.

- Do not place the printer where people may step on the power cord.
- Do not place objects on the power cord.
- Do not obstruct the ventilation openings. These openings are provided to prevent overheating of the printer.



Do not push objects into slots and openings on the printer. Making a contact with a voltage point or shorting out a part could result in fire or electrical shock.

- If you notice unusual noises or odors, switch off the printer power immediately. Disconnect the power cord from the electrical outlet. Call an authorized service representative to correct the problem.
- If any of the following conditions occur, switch off the printer power immediately, disconnect the power cord, and call an authorized service representative.
 - The power cord is damaged or frayed.
 - Liquid is spilled into the printer.
 - The printer is exposed to water.
 - Any part of the printer is damaged.

The power cord is attached to the printer as a plug-in device at the back of the printer. In the event it is necessary to remove all electrical power from the printer, disconnect the power cord from the power receptacle.

Laser Safety



The use of controls or adjustments, or the performance of procedures other than those specified herein, may result in a hazardous radiation exposure.

This equipment complies with all applicable safety standards. With specific regard to laser, the equipment complies with performance standards for laser products set by government agencies as a Class 1 laser product. It does not emit hazardous light; the beam is totally enclosed during all modes of customer operation and maintenance.

When performing various operator functions, you may see laser warning labels. These labels are for the service mode and are placed on or near panels or shields that require a tool for removal. These panels are not to be removed.

Maintenance Safety

- Do not attempt any maintenance procedure that is not specifically described in the documentation supplied with your printer.
- Do not use aerosol cleaners. The use of supplies that are not approved may cause poor performance and could create a dangerous condition.
- Do not remove the covers or guards that are fastened with screws unless you are installing optional equipment. Power should be OFF when performing these installations. Except for user installable options, there are no parts that you can maintain or service behind these covers.
- See *Chapter 4: Maintaining the Printer* for maintenance instructions.

Operational Safety

Your printer and supplies were designed and tested to meet strict safety requirements. These include safety agency examination, approval, and compliance with established environmental standards.

Your attention to the following safety guidelines will help to ensure the continued safe operation of your printer.

- Use the material and supplies specifically designed for your printer. The use of unsuitable materials may result in poor performance and possibly a hazardous situation.
- Follow all warnings and instructions marked on, or supplied with, the printer, options and supplies.
- Place the printer in a dust free area where the temperature range is 41° F to 95° F (5° C to 35° C) and the relative humidity is 15% to 85%.
- Place the printer in an area where there is adequate space for ventilation, operation and servicing. The recommended minimal spacing is 24 in. (600 mm) in front of and behind the printer, and 12 in. (300 mm) on each side of the printer.

- Do not place the printer near a heat source.
- Do not place the printer in direct sunlight.
- Do not place the printer in line with the cold air flow from an air conditioning system.
- Place the printer on a level, solid surface with adequate strength for the weight of the machine. The base printer weight without any packaging materials is 60 pounds (27 kg).
- The printer is heavy. Exercise care in moving or relocating the printer. Follow the recommended procedure when moving the printer from one location to another. See the *User Guide*.
- Do not put containers of coffee or other liquids onto the printer.
- Do not block or cover the slots and openings on the printer. Without adequate ventilation, the printer may overheat.



Be careful when working in areas identified with a warning symbol. These areas may be very hot and could cause personal injury.

- Frequent operation of the on/off switch is not recommended.
- Keep hands, hair, jewelry and neckties away from the exit feed rollers.
- Do not remove a media tray while printing from that tray or any tray above the media tray in use.
- Do not open the covers while printing.
- Do not switch off the printer power while printing.
- Do not move the printer while printing.

Ozone Safety

This printer produces virtually no ozone (< 0.01 ppm) during normal operation. Providing the proper environmental parameters, as specified in the Operational Safety section of these Safety Notes, ensures that concentration levels meet safe limits.

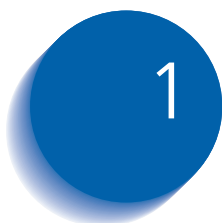

Configuring the Printer

<i>Using the Control Panel</i>	1-3
<i>The Display</i>	1-4
<i>The Indicator Lights</i>	1-5
<i>The Keys</i>	1-6
<i>Menu Symbols</i>	1-9
<i>Navigating the Menu System</i>	1-8
<i>Setting a Menu Option</i>	1-10
<i>Access to Special Operating Modes</i>	1-12
<i>Control Panel Locks</i>	1-13
<i>Using the Menu System</i>	1-14
<i>Menu System Overview</i>	1-14
<i>Job Menu</i>	1-16
<i>Password Menu</i>	1-19
<i>Tray Menu</i>	1-22
<i>PCL Menu</i>	1-35
<i>System Menu</i>	1-42
<i>USB Menu</i>	1-62
<i>Parallel Menu</i>	1-54
<i>Serial Menu</i>	1-58
<i>Ethernet Menu</i>	1-65

<i>Token Ring Menu</i>	1-79
<i>Novell Menu</i>	1-95
<i>Print Menu</i>	1-103
<i>Reset Menu</i>	1-109
<i>Configuring Automatic Tray Switching</i>	1-114
<i>Configuring Output Offsetting</i>	1-125
<i>Configuring Duplex Printing</i>	1-128
<i>Configuring Custom Paper Sizes</i>	1-130

Using the Control Panel

The printer's Control Panel (Figure 1.1) serves several purposes:

- It displays information about the status of the printer (or the job in process).
- It provides the means for changing printer settings to control how the printer operates.
- It allows you to print reports and password-protected pages stored on the optional hard drive.

Figure 1.1 Control Panel

- 1 The display
- 2 Online indicator light
- 3 Form Feed indicator light
- 4 Error indicator light
- 5 Data indicator light
- 6 Online key
Password #0
- 7 Enter key
Password #4
- 8 Menu Up key
Password #1
- 9 Menu Down key
Password #5
- 10 Item Up key
Password #2
- 11 Item Down key
Password #6
- 12 Value Up key
Password #3
- 13 Value Down key
Password #7

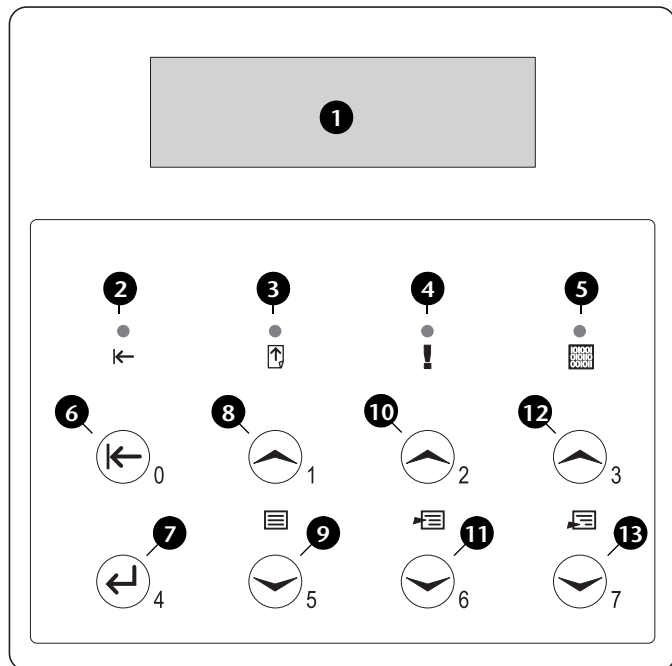

The Display

The Control Panel's display performs two functions.

- It informs you of printer status conditions, such as when toner is low, when a paper tray is empty, when a job is in process, and so on. For example, when you turn on the printer, the display will show:



Ready

This message appears whenever the printer is online and ready to accept print jobs. The display will also show:



Processing...

when processing data, and:

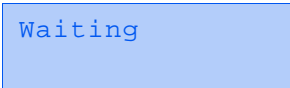

Waiting

when waiting for more data.

- It presents a hierarchy of menu options and settings to configure and control the printer.

For example, when you press **Menu Up** or **Menu Down**, the display will show:



Menus
Item Menu

(such as [System Menu](#) or [Job Menu](#))

See the section “*Menu System Overview*” (page 1-14) for information on the Menu system hierarchy.

The Indicator Lights

The Control Panel contains four indicator lights. Table 1.1 describes the function of each light.

Table 1.1 Indicator lights and their functions

Light	Description
Online (Green)	<p>Lights when the printer is online.</p> <p>Flashes when the printer is transitioning from online to offline or to indicate that a print job is being processed.</p>
Form Feed (Green)	<p>Lights when the printer experiences a form feed timeout—that is, when a PCL job has formatted a partial page, the printer is waiting for more data in order to continue processing the job, and a 15 second timeout period has expired with no new data arriving in the input buffer. This timeout applies to all ports.</p> <p>When lit, you can print a partial page by entering the Job menu, scrolling to the Form Feed item and pressing Enter. When not in the menu system, a partial page can be printed by pressing Enter. PostScript does not print partial pages and consequently the Form Feed light is not turned on.</p>
Error (Amber)	<p>Lights whenever operator intervention is required in order to allow printing to continue.</p>
Data (Green)	<p>Flashes to indicate that a print job is being received and/or processed by either PostScript, PCL or PDL. In the case of proof or secure jobs, the print job is received but is not processed until the required password is entered at the Control Panel, at which time the indicator flashes to indicate processing.</p>

The Keys The Control Panel keypad consists of eight keys, identified with international symbols and/or labeled in English. The keys are also numbered 0 - 7 for use when entering passwords.

Table 1.2 describes the function of each key.

Table 1.2 Control Panel keys and their functions

Key	Description
Online	<ul style="list-style-type: none"> • If the Printer is online and not in the menu system, takes the printer offline. All pages currently in the paper path are printed and then printing pauses until the printer is brought online again. • If the printer is online and in the menu system, exits the menu system. • If the printer is offline and not in the menu system, brings the printer online. • If the printer is offline and in the menu system, exits the menu system and brings the printer online. • If the printer is offline and in power saver mode, brings the printer online.
Enter	<ul style="list-style-type: none"> • If the current display is a value for an item, causes the value to be entered as the current default value for this item. • If the current display is an action to be invoked (e. g. "PCL Font List", "Config. Sheet"), causes the action to occur. • If not in the menu system, and the "Form Feed" LED indicates that a partial page exists, causes an implied PCL reset and the partial page is ejected. • If a paper mismatch condition exists, and a request to use an alternate paper is displayed, causes printing on the paper currently loaded in the selected tray (Print Anyway).
Menu Up	<ul style="list-style-type: none"> • If not in the menu system, enters the menu system and displays the first menu. • If in the menu system, causes the Control Panel to scroll through the menus in order bottom to top.

Table 1.2 Page 1 of 2

Table 1.2 Control Panel keys and their functions (continued)

Key	Description
Menu Down	<ul style="list-style-type: none"> • If not in the menu system, enters the menu system and displays the first menu. • If in the menu system, causes the Control Panel to scroll through the menus in order top to bottom.
Item Up	<ul style="list-style-type: none"> • If in the menu system, causes the Control Panel to scroll through the items in the current menu in order from bottom to top. • If not in the menu system, this key is ignored.
Item Down	<ul style="list-style-type: none"> • If in the menu system, causes the Control Panel to scroll through the items in the current menu in order from top to bottom. • If not in the menu system, this key is ignored.
Value Up	<ul style="list-style-type: none"> • If in the menu system, and an item is displayed, causes the Control Panel to scroll through the values for the current item in order bottom to top, and displays the default value for the current item. When setting a numeric value, increases the value by the step amount. It is subject to auto-repeat if held down by more than 1 second. • If not in the menu system, and a paper mismatch condition does not exist, this key is ignored. • If a paper mismatch condition exists, scrolls through the alternate paper that may be used instead of the requested paper.
Value Down	<ul style="list-style-type: none"> • If in the menu system, and an item is displayed, causes the Control Panel to scroll through the values for the current item in order top to bottom, and displays the default value for the current item. When setting a numeric value, decreases the value by the step amount. It is subject to auto-repeat if held down by more than 1 second. • If not in the menu system, and a paper mismatch condition does not exist, this key is ignored. • If a Paper Mismatch condition exists, pressing this key scrolls through the alternate paper that may be used instead of the requested paper.
Table 1.2 Page 2 of 2	

Navigating the Menu System

The Control Panel contains the following menu structure. Press **Menu Up** or **Menu Down** to access the Main Menu. Each of the submenus may have other submenus, settings, actions or functions.

- Job Menu
- Password Menu¹
- Tray Menu
- PCL Menu
- System Menu
- Parallel Menu
- Serial Menu²
- USB Menu
- Ethernet Menu³
- Token Ring Menu⁴
- Novell Menu⁵
- Print Menu
- Reset Menu



*The Reset Menu is included in the menu list by simultaneously holding down **Online** and **Enter** when the printer is being powered up. See the section “Reset Menu” (page 1-109) for more information.*

1. Available only if the optional Hard Disk Drive is installed.

2. Available only if the Serial option is installed.

3. Available only if the printer is network capable, but not if the Token Ring Card is installed.

4. Available only if the printer is network capable, and the Token Ring Card is installed.

5. Available only if the printer is network capable.

Menu Symbols

Two menu symbols (= and *) are used to furnish information about menus and settings. The purpose of each symbol is described in Table 1.3 below.

Table 1.3 Symbols found in the Control Panel Menu systems

Symbol	Purpose	Example
=	<p>When at a point where a value may be changed, the item name is displayed on the top line with the = symbol in the last character position, and the selected value is displayed on the bottom line.</p> <p>The example at the right tells you that Language is an option that takes a specific setting. One setting for the Language option is Français. Another setting is English. (The list of available settings is displayed one setting at a time on the bottom line of the display as you press Value Up or Value Down.)</p>	<p>Language = Français</p>
*	<p>When first arriving at a point where a setting may be changed, the current value is displayed on the bottom line and a * symbol appears next to it in the last character position. Pressing Up Value or Down Value scrolls through the possible values. Whenever the current value is displayed, the * is displayed in the last character position. Pressing Enter causes the * to display in the last character position for the new value. Since pressing Enter causes the display to indicate the current menu and current item, the asterisk may not be seen until the item and current value is displayed again by pressing a Value key.</p> <p>The example at the right tells you that Language is currently set to English.</p>	<p>Language = English *</p>

Setting a Menu Option

To set an option or to invoke a function, follow the steps below:

- 1 Press **Menu Up** or **Menu Down** to scroll through the available submenus until you locate the one you want.

You will see:

```
Menu  
Menu Name
```

Where *Menu Name* is the current submenu displayed.

- 2 Press **Item Up** or **Item Down** to scroll through the items of the submenu (all submenus except the Password Menu).

You will see:

```
Menu Name  
Item Name
```

Where *Item Name* is the current item displayed. For the Job, Print and Reset Menus, the bottom line of the display indicates the action to be taken (e.g., Config. Sheet or PCL Font List).

- 3 Press **Value Up** or **Value Down** to select the appropriate value for this item.

You will see:

```
Item Name      =
Current Value*
```

If a list of many values exists (e.g., 1 through 99 for number of copies), you can scroll quickly by holding down **Value Up** or **Value Down**.

When you see the value you want, press **Enter** to accept it.

- 4 If necessary, repeat Steps 1 through 3 to go through other menus, options, actions, functions and values.

After you press **Enter** to accept a value, the menu will display:

```
Menu Name
Item Name
```

You may either continue to work in the Menu system by repeating the steps above, or exit and return to normal operation by pressing **Online**.



*If you press **Online** at any time prior to pressing **Enter** the new value will not be saved and the Menu system is exited.*



The printer automatically exits the Menu system after 60 seconds of inactivity (i.e., no key has been pressed).

Access to Special Operating Modes

The printer may be placed in special diagnostic or other operating modes by turning on power while holding down two keys on the Control Panel. The following are the key combinations for each mode:

Table 1.4 Access to special operating modes

Key Combinations	Mode
On-line and Enter (Keys numbered 0 and 4)	Enables the "Reset" menu.
Menu Up and Menu Down (Keys numbered 1 and 5)	Forces the "Software Update" mode on the Parallel port.

Control Panel Locks

Some of the menus in the Control Panel may be “locked” to prevent unauthorized access and changes to system parameters. This is accomplished with the PJL “CPLOCK” command. If the user scrolls to a locked menu, pushing either “Item” key will cause the menu name to appear on the top line, and “Menu Locked” to appear on the second line. Menus are unlocked only with the corresponding PJL “CPLOCK” command. Only the following menus are available from the Control Panel when locked:

- Job Menu
- Password Menu (if optional Hard Drive is installed)
- Tray Menu
- Print Menu
- Reset Menu

If you do not want users to have access to the Reset Menu, power OFF and power ON the printer.

Using the Menu System

Menu System Overview

The Main Menu is a system of submenus, each containing options designed to configure the printer for your environment. The Main Menu hierarchy is depicted in Table 1.5 on page 1-15.



In this chapter, a boldfaced value followed by an asterisk () indicates the factory default for that value. See the section “Reset Menu” (page 1-109) for information on how to revert to factory settings.*

Table 1.5 Main Menu hierarchy

Main Menu	Hierarchy and Factory Settings
Job Menu	See "Job Menu" (page 1-16).
Password Menu ¹	See "Password Menu" (page 1-19).
Tray Menu	See "Tray Menu" (page 1-22).
PCL Menu	See "PCL Menu" (page 1-35).
System Menu	See "System Menu" (page 1-42).
Parallel Menu	See "Parallel Menu" (page 1-54).
Serial Menu ²	See "Serial Menu" (page 1-58)
USB Menu	See "USB Menu" (page 1-62).
Ethernet Menu ³	See "Ethernet Menu" (page 1-65).
Token Ring Menu ⁴	See "Token Ring Menu" (page 1-79)
Novell Menu ⁵	See "Novell Menu" (page 1-95).
Print Menu	See "Print Menu" (page 1-103)
Reset Menu ⁶	See "Reset Menu" (page 1-109).

¹ Appears only if the optional Hard Disk Drive is installed.

² Appears only if the Serial Interface option is installed.

³ Appears only if the printer is network capable and the Token Ring card is not installed.

⁴ Appears only if the printer is network capable and the Token Ring card is installed.

⁵ Appears only if the printer is network capable.

⁶ Appears only when **Online** and **Enter** keys are simultaneously held down at power On.

Job Menu

The Job Menu and its available items are described in Table 1.6.

Table 1.6 Job Menu Items

Menu	Description	
Job Menu	Allows you to cancel the job currently processed by PCL or PostScript, or to force a form feed on a partially formatted job in PCL.	
	Menu Items	Description
	Cancel Job	Cancels the job currently printing.
	Form Feed	Causes a partial PCL page to be ejected when the Form Feed LED is on.
Restart Printer	Re-boots the printer as if the power was cycled, but bypasses power on diagnostics.	

Refer to Table 1.7 on page 1-17 for step-by-step instructions.

Table 1.7 Job Menu Functions

Menu Item and Function	Keystrokes	Display Reads
Cancel Job Cancel the job currently printing (Postscript or PCL). The available values are: Yes No*	1. Press Menu Up or Menu Down until you see:	Menus Job Menu
	2. Press Item Up or Item Down until you see:	Job Menu Cancel Job
	3. Press Value Up or Value Down until you see:	Cancel Job Yes
	4. Press Enter . You will see:	Cancelling Job Filename
	5. When the action is complete, you will see:	Ready
Form Feed Eject a partial PCL page when the Form Feed LED is ON. The available values are: Yes No*	1. Press Menu Up or Menu Down until you see:	Menus Job Menu
	2. Press Item Up or Item Down until you see:	Job Menu Form Feed
	3. Press Value Up or Value Down until you see:	Form Feed Yes
	4. Press Enter . When the action is complete, you will see:	Ready

Table 1.7 Page 1 of 2

Table 1.7 Job Menu Functions *(continued)*

Menu Item and Function	Keystrokes	Display Reads
<p>Restart Printer</p> <p>Reinitialize the printer as if the power was cycled.</p> <p>The available values are:</p> <p>Yes No*</p>	1. Press Menu Up or Menu Down until you see:	<p>Menus</p> <p>Job Menu</p>
	2. Press Item Up or Item Down until you see:	<p>Job Menu</p> <p>Restart Printer</p>
	3. Press Value Up or Value Down until you see:	<p>Restart Printer</p> <p>Yes</p>
	4. Press Enter . You will see:	<p>[Startup Messages]</p>
	5. When the action is complete, you will see:	<p>Ready</p>

Table 1.7 Page 2 of 2

Password Menu

Use the Password Menu (available only when the optional Hard Drive is installed) to print or delete secure or proof jobs. Secure and proof jobs are enabled by drivers.

Refer to Table 1.8 for step-by-step procedures.

Table 1.8 Password Menu Functions

Menu Item and Function	Keystrokes	Display Reads
All Jobs Print Print all jobs sent with a specific password.	1. Press Menu Up or Menu Down until you see:	Menus Password Menu
	2. Press Item Up or Item Down . You will see:	Enter Password _xxx
	3. Enter four-digit password using the numbers on the Control Panel keys. You will see:	All Jobs Print
	4. Press Enter . When print is completed you will see:	Ready

Table 1.8 Page 1 of 3

Table 1.8 Password Menu Functions (continued)

Menu Item and Function	Keystrokes	Display Reads
<p>Filename n Print</p> <p>Print one or more jobs out of several sent with a specific password.</p> <p>A job with a name assigned to it will replace the "Filename n" with that name.</p>	1. Press Menu Up or Menu Down until you see:	Menus Password Menu
	2. Press Item Up or Item Down . You will see:	Enter Password _xxx
	3. Enter four-digit password using the numbers on the Control Panel keys. You will see:	All Jobs Print
	4. Press Item Up or Item Down until you see:	Filename n Print
	5. Press Enter . You will see:	Printing Filename n
	6. Repeat Steps 4 and 5 until you have identified all the jobs you wish to print. When done, press Online . You will see:	Ready
<p>All Jobs Delete</p> <p>Delete all jobs sent with a specific password.</p>	1. Press Menu Up or Menu Down until you see:	Menus Password Menu
	2. Press Item Up or Item Down . You will see:	Enter Password _xxx
	3. Enter four-digit password using the numbers on the Control Panel keys. You will see:	All Jobs Print
	4. Press Value Up or Value Down until you see:	All Jobs Delete
	5. Press Enter . You will see:	Ready

Table 1.8 Page 2 of 3

Table 1.8 Password Menu Functions (continued)

Menu Item and Function	Keystrokes	Display Reads
Filename n Delete Delete one or more jobs out of several sent with a specific password.	1. Press Menu Up or Menu Down until you see:	Menus Password Menu
	2. Press Item Up or Item Down . You will see:	Enter Password _xxx
	3. Enter four-digit password using the numbers on the Control Panel keys. You will see:	All Jobs Print
	4. Press Item Up or Item Down until you see:	Filename n Print
	5. Press Value Up or Value Down until you see:	Filename n Delete
	6. Press Enter . You will see:	All Jobs Print
	7. Repeat Steps 4 to 6 until you have deleted all the jobs you wish to delete. When done, press Online . You will see:	Ready
Table 1.8 Page 3 of 3		

Tray Menu

The Tray Menu and its available items are described in Table 1.9.

Table 1.9 Tray Menu Items

Menu	Description	
Tray Menu	Allows you to access tray settings for PCL and PostScript jobs.	
	Menu Items	Description
	MBF Size	Defines the paper size that is loaded in the MBF.
	MBF Type	Defines the paper type that is loaded in the MBF.
	Envelope Size	Defines the paper size that is loaded in the optional envelope feeder.
	Envelope Type	Defines the paper type that is loaded in the optional envelope feeder.
	Tray <i>N</i> Type	Defines the type of paper installed in Tray <i>N</i> (where <i>N</i> is the tray number—Tray 1, 2, or 3).
	Tray Sequence	Groups two or more trays together so the group appears as one logical tray, and defines the order in which the trays will be searched to satisfy the input request.
	Custom Size	Defines the paper size that is used in formatting pages printed from the tray(s) if Tray <i>N</i> Mode is set to <i>Custom</i> (which overrides the tray's auto size detection mechanism).
	Tray <i>N</i> Mode	Determines whether or not the auto size detection mechanism in tray <i>N</i> (where <i>N</i> is the tray number—Tray 1, 2, or 3) should be overridden with the setting for Custom Size .
Config Fuser	Enables the customization of fuser temperature settings associated with each paper type (otherwise set automatically by the printer). When set to <i>On</i> , each paper type is available as a menu item to customize its fuser temperature.	

Table 1.9 Page 1 of 2

Table 1.9 Tray Menu Items

Menu	Description	
Tray Menu (continued)	Plain	Sets the fuser temperature to be associated with the paper type <i>Plain</i> (appears only if Config Fuser is set to <i>On</i>).
	Preprinted	Sets the fuser temperature to be associated with the paper type <i>Preprinted</i> (appears only if Config Fuser is set to <i>On</i>).
	Letterhead	Sets the fuser temperature to be associated with the paper type <i>Letterhead</i> (appears only if Config Fuser is set to <i>On</i>).
	Prepunched	Sets the fuser temperature to be associated with the paper type <i>Prepunched</i> (appears only if Config Fuser is set to <i>On</i>).
	Labels	Sets the fuser temperature to be associated with the paper type <i>Labels</i> (appears only if Config Fuser is set to <i>On</i>).
	Bond	Sets the fuser temperature to be associated with the paper type <i>Bond</i> (appears only if Config Fuser is set to <i>On</i>).
	Recycled	Sets the fuser temperature to be associated with the paper type <i>Recycled</i> (appears only if Config Fuser is set to <i>On</i>).
	Color	Sets the fuser temperature to be associated with the paper type <i>Color</i> (appears only if Config Fuser is set to <i>On</i>).
	Cardstock	Sets the fuser temperature to be associated with the paper type <i>Cardstock</i> (appears only if Config Fuser is set to <i>On</i>).
	User type <i>N</i>	Sets the fuser temperature to be associated with the custom paper type of <i>User type n</i> (appears only if Config Fuser is set to <i>On</i> and the paper type has been defined through CentreWare).

Table 1.9 Page 2 of 2

Refer to Table 1.10 on page 1-24 for step-by-step procedures.

Table 1.10 Tray Menu Functions

Menu Item and Function	Keystrokes	Display Reads
<p>MBF Size</p> <p>Set the paper size that is loaded in the multi bypass feeder (MBF). This item must be entered manually because the MBF does not have paper size sensing. The available values are:</p> <p>Statmt(5.5x8.5) Exec(7.25x10.5) Letter(8.5x11)* Legal(8.5x14) Folio(8.5x13) A6(105x148) A5(148x210) A4(210x297)* B5-JIS(182x257) B5-ISO(176x250) Index(3x5) Com10(4.1x9.5) C5(162x229) DL(110x220) Monarc(3.8x7.5) Custom</p> <p><i>Letter</i> is the inches default. <i>A4</i> is the millimeters default.</p>	<p>1. Press Menu Up or Menu Down until you see:</p>	<p>Menus Tray Menu</p>
	<p>2. Press Item Up or Item Down until you see:</p>	<p>Tray Menu MBF Size</p>
	<p>3. Press Value Up or Value Down until you see:</p>	<p>MBF Size = New Value</p>
	<p>4. Press Enter. You will see:</p>	<p>Tray Menu MBF Size</p>
	<p>5. Press On Line. You will see:</p>	<p>Ready</p>

Table 1.10 Page 1 of 11

Table 1.10 Tray Menu Functions (continued)

Menu Item and Function	Keystrokes	Display Reads
MBF Type Set the type of paper that is loaded in the multi bypass feeder (MBF). The available values are: Plain* Color Preprinted Cardstock Letterhead User Type 1 (if loaded) Transparency User Type 2 (if loaded) Prepunched User Type 3 (if loaded) Labels User Type 4 (if loaded) Bond User Type 5 (if loaded) Recycled	1. Press Menu Up or Menu Down until you see:	Menus Tray Menu
	2. Press Item Up or Item Down until you see:	Tray Menu MBF Type
	3. Press Value Up or Value Down until you see:	MBF Type = New Value
	4. Press Enter . You will see:	Tray Menu MBF Type
	5. Press On Line . You will see:	Ready
Envelope Size Set the paper size that is loaded in the envelope feeder. This item must be entered manually because the envelope feeder does not have paper size sensing. The available values are: Com10(4.125x9.5) C5(162x229) DL(110x220) Monarc(3.87x7.5) A6(105x148) Custom <i>Com10</i> is the inches default. <i>DL</i> is the millimeters default.	1. Press Menu Up or Menu Down until you see:	Menus Tray Menu
	2. Press Item Up or Item Down until you see:	Tray Menu Envelope Size
	3. Press Value Up or Value Down until you see:	Envelope Size = New Value
	4. Press Enter . You will see:	Tray Menu Envelope Size
	5. Press On Line . You will see:	Ready

Table 1.10 Page 2 of 11

Table 1.10 Tray Menu Functions (continued)

Menu Item and Function	Keystrokes	Display Reads
Envelope Type Set the type of paper that is loaded in the multi bypass feeder (MBF). The available values are: Plain* Color Preprinted Cardstock Letterhead User Type 1 (if loaded) Transparency User Type 2 (if loaded) Prepunched User Type 3 (if loaded) Labels User Type 4 (if loaded) Bond User Type 5 (if loaded) Recycled	1. Press Menu Up or Menu Down until you see:	Menus Tray Menu
	2. Press Item Up or Item Down until you see:	Tray Menu Envelope Type
	3. Press Value Up or Value Down until you see:	Envelope Type = New Value
	4. Press Enter . You will see:	Tray Menu Envelope Type
	5. Press On Line . You will see:	Ready
Tray n Type Set the type of paper that is loaded in Tray <i>n</i> (where <i>n</i> is the tray number—1, 2, or 3). The available values are: Plain* Color Preprinted Cardstock Letterhead User Type 1 (if loaded) Transparency User Type 2 (if loaded) Prepunched User Type 3 (if loaded) Labels User Type 4 (if loaded) Bond User Type 5 (if loaded) Recycled	1. Press Menu Up or Menu Down until you see:	Menus Tray Menu
	2. Press Item Up or Item Down until you see:	Tray Menu Tray 1 Type
	3. Press Value Up or Value Down until you see:	Tray 1 Type = New Value
	4. Press Enter . You will see:	Tray Menu Tray 1 Type
	5. Press On Line . You will see:	Ready

Table 1.10 Page 3 of 11

Table 1.10 Tray Menu Functions (continued)

Menu Item and Function	Keystrokes	Display Reads																		
<p>Tray Sequence</p> <p>Set the sequence of trays used by the printer when tray switching is required. The available values are:</p> <table border="0"> <tr> <td>MBF-1*</td> <td>1-MBF</td> </tr> <tr> <td>MBF-2</td> <td>1-2</td> </tr> <tr> <td>MBF-3</td> <td>1-2-3</td> </tr> <tr> <td>MBF-1-2</td> <td>2-1</td> </tr> <tr> <td>MBF-1-2-3</td> <td>2-3</td> </tr> <tr> <td>MBF-2-1**</td> <td>3-1</td> </tr> <tr> <td>MBF-2-3</td> <td>3-1-2</td> </tr> <tr> <td>MBF-3-1</td> <td>Off</td> </tr> <tr> <td>MBF-3-1-2***</td> <td></td> </tr> </table> <p><i>Values in italics are available only with optional tray(s) installed.</i></p> <p><i>* the default if no optional feeders are installed.</i></p> <p><i>** the default if only optional Tray 2 is installed.</i></p> <p><i>*** the default if optional Trays 2 and 3 are installed.</i></p> <p>The first tray of a sequence is used until it runs out of paper, at which time the next tray in the sequence is used (if it has the correct paper size and type).</p> <p>See the section “Configuring Automatic Tray Switching” (page 1-114) for rules and examples of usage.</p>	MBF-1*	1-MBF	MBF-2	1-2	MBF-3	1-2-3	MBF-1-2	2-1	MBF-1-2-3	2-3	MBF-2-1**	3-1	MBF-2-3	3-1-2	MBF-3-1	Off	MBF-3-1-2***		1. Press Menu Up or Menu Down until you see:	Menus Tray Menu
	MBF-1*	1-MBF																		
	MBF-2	1-2																		
	MBF-3	1-2-3																		
	MBF-1-2	2-1																		
MBF-1-2-3	2-3																			
MBF-2-1**	3-1																			
MBF-2-3	3-1-2																			
MBF-3-1	Off																			
MBF-3-1-2***																				
2. Press Item Up or Item Down until you see:	Tray Menu Tray Sequence																			
3. Press Value Up or Value Down until you see:	Tray Sequence = New Value																			
4. Press Enter . You will see:	Tray Menu Tray Sequence																			
5. Press On Line . You will see:	Ready																			

Table 1.10 Page 4 of 11

Table 1.10 Tray Menu Functions (continued)

Menu Item and Function	Keystrokes	Display Reads
<p>Custom Size</p> <p>Set the paper size that is to be used for formatting custom paper when a Tray Mode is set to <i>Custom</i>. The available values are:</p> <p>Statmt(5.5x8.5) Exec(7.25x10.5) Letter(8.5x11)* Legal(8.5x14) Folio(8.5x13) A6(105x148) A5(148x210) A4(210x297)* B5-JIS(182x257) B5-ISO(176x250) Index(3x5) Com10(4.125x9.5) C5(162x229) DL(110x220) Monarc(3.87x7.5)</p> <p><i>Letter</i> is the inches default. <i>A4</i> is the millimeters default.</p>	1. Press Menu Up or Menu Down until you see:	Menus Tray Menu
	2. Press Item Up or Item Down until you see:	Tray Menu Custom Size
	3. Press Value Up or Value Down until you see:	Custom Size = New Value
	4. Press Enter . You will see:	Tray Menu Custom Size
	5. Press On Line . You will see:	Ready
<p>Tray N Mode</p> <p>Determine whether or not to use Tray <i>N</i>'s auto size detection mechanism or Custom Size settings. The available values are:</p> <p>Auto* Custom</p>	1. Press Menu Up or Menu Down until you see:	Menus Tray Menu
	2. Press Item Up or Item Down until you see:	Tray Menu Tray N Mode
	3. Press Value Up or Value Down until you see:	Tray N Mode = New Value
	4. Press Enter . You will see:	Tray Menu Tray N Mode
	5. Press On Line . You will see:	Ready

Table 1.10 Page 5 of 11

Table 1.10 Tray Menu Functions (continued)

Menu Item and Function	Keystrokes	Display Reads
<p>Config Fuser</p> <p>Enable the customization of fuser temperature settings associated with each paper type (otherwise set automatically by the printer).</p> <p>The available values are:</p> <p>On Off*</p> <p>When set to <i>On</i>, each paper type is available as a menu item to customize its fuser temperature (see the following items in this table).</p>	1. Press Menu Up or Menu Down until you see:	Menus Tray Menu
	2. Press Item Up or Item Down until you see:	Tray Menu Config Fuser
	3. Press Value Up or Value Down until you see:	Config Fuser = New Value
	4. Press Enter . You will see:	Tray Menu Config Fuser
	5. Press Online . You will see:	Ready
<p>Plain</p> <p>Set the fuser temperature to be associated with the paper type of <i>Plain</i>.</p> <p>The available values are:</p> <p>Normal* High Low</p> <p>This item appears only when the Config Fuser item is set to <i>On</i>.</p>	1. Press Menu Up or Menu Down until you see:	Menus Tray Menu
	2. Press Item Up or Item Down until you see:	Tray Menu Plain
	3. Press Value Up or Value Down until you see:	Plain = New Value
	4. Press Enter . You will see:	Tray Menu Plain
	5. Press Online . You will see:	Ready

Table 1.10 Page 6 of 11

Table 1.10 Tray Menu Functions (continued)

Menu Item and Function	Keystrokes	Display Reads
<p>Preprinted</p> <p>Set the fuser temperature to be associated with the paper type of <i>Preprinted</i>.</p> <p>The available values are:</p> <p>Normal* High Low</p> <p>This item appears only when the Config Fuser item is set to <i>On</i>.</p>	1. Press Menu Up or Menu Down until you see:	Menus Tray Menu
	2. Press Item Up or Item Down until you see:	Tray Menu Preprinted
	3. Press Value Up or Value Down until you see:	Preprinted = New Value
	4. Press Enter . You will see:	Tray Menu Preprinted
	5. Press Online . You will see:	Ready
<p>Letterhead</p> <p>Set the fuser temperature to be associated with the paper type of <i>Letterhead</i>.</p> <p>The available values are:</p> <p>Normal* High Low</p> <p>This item appears only when the Config Fuser item is set to <i>On</i>.</p>	1. Press Menu Up or Menu Down until you see:	Menus Tray Menu
	2. Press Item Up or Item Down until you see:	Tray Menu Letterhead
	3. Press Value Up or Value Down until you see:	Letterhead = New Value
	4. Press Enter . You will see:	Tray Menu Letterhead
	5. Press Online . You will see:	Ready

Table 1.10 Page 7 of 11

Table 1.10 Tray Menu Functions (continued)

Menu Item and Function	Keystrokes	Display Reads
<p>Prepunched</p> <p>Set the fuser temperature to be associated with the paper type of <i>Prepunched</i>.</p> <p>The available values are:</p> <p>Normal* High Low</p> <p>This item appears only when the Config Fuser item is set to <i>On</i>.</p>	1. Press Menu Up or Menu Down until you see:	Menus Tray Menu
	2. Press Item Up or Item Down until you see:	Tray Menu Prepunched
	3. Press Value Up or Value Down until you see:	Prepunched = New Value
	4. Press Enter . You will see:	Tray Menu Prepunched
	5. Press Online . You will see:	Ready
<p>Labels</p> <p>Set the fuser temperature to be associated with the paper type of <i>Labels</i>.</p> <p>The available values are:</p> <p>Normal High* Low</p> <p>This item appears only when the Config Fuser item is set to <i>On</i>.</p>	1. Press Menu Up or Menu Down until you see:	Menus Tray Menu
	2. Press Item Up or Item Down until you see:	Tray Menu Labels
	3. Press Value Up or Value Down until you see:	Labels = New Value
	4. Press Enter . You will see:	Tray Menu Labels
	5. Press Online . You will see:	Ready

Table 1.10 Page 8 of 11

Table 1.10 Tray Menu Functions (continued)

Menu Item and Function	Keystrokes	Display Reads
<p>Bond</p> <p>Set the fuser temperature to be associated with the paper type of <i>Bond</i>.</p> <p>The available values are:</p> <p>Normal* High Low</p> <p>This item appears only when the Config Fuser item is set to <i>On</i>.</p>	1. Press Menu Up or Menu Down until you see:	Menus Tray Menu
	2. Press Item Up or Item Down until you see:	Tray Menu Bond
	3. Press Value Up or Value Down until you see:	Bond = New Value
	4. Press Enter . You will see:	Tray Menu Bond
	5. Press Online . You will see:	Ready
<p>Recycled</p> <p>Set the fuser temperature to be associated with the paper type of <i>Recycled</i>.</p> <p>The available values are:</p> <p>Normal* High Low</p> <p>This item appears only when the Config Fuser item is set to <i>On</i>.</p>	1. Press Menu Up or Menu Down until you see:	Menus Tray Menu
	2. Press Item Up or Item Down until you see:	Tray Menu Recycled
	3. Press Value Up or Value Down until you see:	Recycled = New Value
	4. Press Enter . You will see:	Tray Menu Recycled
	5. Press Online . You will see:	Ready

Table 1.10 Page 9 of 11

Table 1.10 Tray Menu Functions (continued)

Menu Item and Function	Keystrokes	Display Reads
<p>Color</p> <p>Set the fuser temperature to be associated with the paper type of <i>Color</i>.</p> <p>The available values are:</p> <p>Normal* High Low</p> <p>This item appears only when the Config Fuser item is set to <i>On</i>.</p>	1. Press Menu Up or Menu Down until you see:	Menus Tray Menu
	2. Press Item Up or Item Down until you see:	Tray Menu Color
	3. Press Value Up or Value Down until you see:	Color = New Value
	4. Press Enter . You will see:	Tray Menu Color
	5. Press Online . You will see:	Ready
<p>Cardstock</p> <p>Set the fuser temperature to be associated with the paper type of <i>Cardstock</i>.</p> <p>The available values are:</p> <p>Normal High* Low</p> <p>This item appears only when the Config Fuser item is set to <i>On</i>.</p>	1. Press Menu Up or Menu Down until you see:	Menus Tray Menu
	2. Press Item Up or Item Down until you see:	Tray Menu Cardstock
	3. Press Value Up or Value Down until you see:	Cardstock = New Value
	4. Press Enter . You will see:	Tray Menu Cardstock
	5. Press Online . You will see:	Ready

Table 1.10 Page 10 of 11

Table 1.10 Tray Menu Functions (continued)

Menu Item and Function	Keystrokes	Display Reads
<p>User type <i>n</i></p> <p>Set the fuser temperature to be associated with the custom paper type of <i>User type n</i> (where <i>n</i> is 1-5).</p> <p>The available values are:</p> <p>Normal* High Low</p> <p>This item appears only when the Config Fuser item is set to <i>On</i>, and the user types have been named (loaded).</p>	1. Press Menu Up or Menu Down until you see:	Menus Tray Menu
	2. Press Item Up or Item Down until you see:	Tray Menu User type <i>n</i>
	3. Press Value Up or Value Down until you see:	User type <i>n</i> = New Value
	4. Press Enter . You will see:	Tray Menu User type <i>n</i>
	5. Press Online . You will see:	Ready
Table 1.10 Page 11 of 11		

PCL Menu

The PCL Menu and its available items are described in Table 1.11.

Table 1.11 PCL Menu Items

Menu	Description	
PCL Menu	Allows you to establish the default configuration for the printer when printing PCL emulation jobs.	
	Menu Items	Description
	Font Number	Sets the default font in PCL.
	Pitch	Sets the pitch of the default font in PCL. Appears only when the default font already selected is a scalable fixed pitch font.
	Point Size	Sets the point size of the default font in PCL. Appears only when the default font already selected is a scalable proportional spaced font.
	Symbol Set	Sets the default font symbol set used in PCL.
	Orientation	Sets the default orientation (portrait, landscape) used in PCL.
	Form Length	Sets the default number of lines per page used in PCL.
	Line Terminat.	Enables the setting of an additional carriage return after every line feed appearing in PCL text.

Refer to Table 1.12 on page 1-36 for step-by-step procedures.

Table 1.12 PCL Menu Functions

Menu Item and Function	Keystrokes	Display Reads
<p>Font Number</p> <p>Set the ID of the default font in PCL.</p> <p>The available values are: 0* - 999</p> <p>To see the assigned font numbers, print a PCL Font List.</p> <p>The font number changes incrementally to the next valid ID each time either Value Up or Value Down is pressed. Holding down Value Up or Value Down causes continuous scrolling through the font numbers.</p>	1. Press Menu Up or Menu Down until you see:	Menus PCL Menu
	2. Press Item Up or Item Down until you see:	PCL Menu Font Number
	3. Press Value Up or Value Down until you see:	Font Number = New Value
	4. Press Enter . You will see:	PCL Menu Font Number
	5. Press Online . You will see:	Ready
<p>Pitch</p> <p>Set the pitch when the font selected is a scaleable fixed pitch font. Pitch is measured in characters per inch or c.p.i.</p> <p>The available values are: .44 - 99.99 (10.00*)</p> <p>The pitch changes incrementally by .01 each time either Value Up or Value Down is pressed. Holding down Value Up or Value Down causes continuous scrolling through the Pitch values.</p>	1. Press Menu Up or Menu Down until you see:	Menus PCL Menu
	2. Press Item Up or Item Down until you see:	PCL Menu Pitch
	3. Press Value Up or Value Down until you see:	Pitch = New Value
	4. Press Enter . You will see:	PCL Menu Pitch
	5. Press Online . You will see:	Ready

Table 1.12 Page 1 of 6

Table 1.12 PCL Menu Functions (continued)

Menu Item and Function	Keystrokes	Display Reads
<p>Point Size</p> <p>Set the point size when the font selected is a scaleable proportional font. Point size is measured in parts per 72 of an inch.</p> <p>The available values are: 4.00 - 999.75 (12.00*)</p> <p>The point size changes incrementally by .25 each time either Value Up or Value Down is pressed. Holding down Value Up or Value Down causes continuous scrolling through the point sizes.</p>	1. Press Menu Up or Menu Down until you see:	Menus PCL Menu
	2. Press Item Up or Item Down until you see:	PCL Menu Point Size
	3. Press Value Up or Value Down until you see:	Point Size = New Value
	4. Press Enter . You will see:	PCL Menu Point Size
	5. Press Online . You will see:	Ready

Table 1.12 Page 2 of 6

Table 1.12 PCL Menu Functions *(continued)*

Menu Item and Function	Keystrokes	Display Reads																																				
<p>Symbol Set</p> <p>Set the default font symbol set used in PCL.</p> <p>The available values are:</p> <table border="0"> <tr> <td>Desktop</td> <td>Legal</td> <td>Vn Int'l.</td> </tr> <tr> <td>ISO L1</td> <td>Math-8</td> <td>Vn Math</td> </tr> <tr> <td>ISO L2</td> <td>Ms Publ.</td> <td>Vn US</td> </tr> <tr> <td>ISO L5</td> <td>PC-8*</td> <td>Win 3.0</td> </tr> <tr> <td>ISO-4</td> <td>PC-8 DN</td> <td>Win L1</td> </tr> <tr> <td>ISO-6</td> <td>PC-8 Tk</td> <td>Win L2</td> </tr> <tr> <td>ISO-11</td> <td>PC-850</td> <td>Win L5</td> </tr> <tr> <td>ISO-15</td> <td>PC-852</td> <td>ISO Latin Cyr</td> </tr> <tr> <td>ISO-17</td> <td>Pi Font</td> <td>PC Cyrillic</td> </tr> <tr> <td>ISO-21</td> <td>PS Math</td> <td>Latin 6</td> </tr> <tr> <td>ISO-60</td> <td>PS Text</td> <td>ISO L6</td> </tr> <tr> <td>ISO-69</td> <td>Roman-8</td> <td></td> </tr> </table> <p>The symbol set is a collection of characters available for a font, including uppercase and lowercase alphabets, punctuation marks, and special characters such as open and close quotation marks or international characters.</p>	Desktop	Legal	Vn Int'l.	ISO L1	Math-8	Vn Math	ISO L2	Ms Publ.	Vn US	ISO L5	PC-8*	Win 3.0	ISO-4	PC-8 DN	Win L1	ISO-6	PC-8 Tk	Win L2	ISO-11	PC-850	Win L5	ISO-15	PC-852	ISO Latin Cyr	ISO-17	Pi Font	PC Cyrillic	ISO-21	PS Math	Latin 6	ISO-60	PS Text	ISO L6	ISO-69	Roman-8		<p>1. Press Menu Up or Menu Down until you see:</p>	<p>Menus PCL Menu</p>
	Desktop	Legal	Vn Int'l.																																			
	ISO L1	Math-8	Vn Math																																			
	ISO L2	Ms Publ.	Vn US																																			
	ISO L5	PC-8*	Win 3.0																																			
ISO-4	PC-8 DN	Win L1																																				
ISO-6	PC-8 Tk	Win L2																																				
ISO-11	PC-850	Win L5																																				
ISO-15	PC-852	ISO Latin Cyr																																				
ISO-17	Pi Font	PC Cyrillic																																				
ISO-21	PS Math	Latin 6																																				
ISO-60	PS Text	ISO L6																																				
ISO-69	Roman-8																																					
	<p>2. Press Item Up or Item Down until you see:</p>	<p>PCL Menu Symbol Set</p>																																				
	<p>3. Press Value Up or Value Down until you see:</p>	<p>Symbol Set = New Value</p>																																				
	<p>4. Press Enter. You will see:</p>	<p>PCL Menu Symbol Set</p>																																				
	<p>5. Press Online. You will see:</p>	<p>Ready</p>																																				

Table 1.12 PCL Menu Functions (continued)

Menu Item and Function	Keystrokes	Display Reads
Orientation Set the default orientation used in PCL. The available values are: Portrait* Landscape	1. Press Menu Up or Menu Down until you see:	Menus PCL Menu
	2. Press Item Up or Item Down until you see:	PCL Menu Orientation
	3. Press Value Up or Value Down until you see:	Orientation = New Value
	4. Press Enter . You will see:	PCL Menu Orientation
	5. Press Online . You will see:	Ready

Table 1.12 Page 4 of 6

Table 1.12 PCL Menu Functions (continued)

Menu Item and Function	Keystrokes	Display Reads
<p>Form Length</p> <p>Set the default text length (number of lines on a page) used in PCL.</p> <p>The available values are:</p> <p>5 - 128 (60* when Defaults = Inches) (64* when Defaults = Millimeters)</p> <p>Form Length is automatically adjusted when Paper Size is changed. The Form Length is recalculated using the formula: Form Length = ((page length in inches - 1 inch) * 6).</p> <p>The Form Length value changes incrementally by 1 each time either Value Up or Value Down is pressed. Holding down Value Up or Value Down causes continuous scrolling through the Form Length values.</p> <p>The value of this setting after performing a Factory Reset depends on the value of the Default units (inches, millimeters).</p>	1. Press Menu Up or Menu Down until you see:	Menus PCL Menu
	2. Press Item Up or Item Down until you see:	PCL Menu Form Length
	3. Press Value Up or Value Down until you see:	Form Length = New Value
	4. Press Enter . You will see:	PCL Menu Form Length
	5. Press Online . You will see:	Ready

Table 1.12 Page 5 of 6

Table 1.12 PCL Menu Functions (continued)

Menu Item and Function	Keystrokes	Display Reads
<p>Line Terminat.</p> <p>Set to add a Carriage Return after every Line Feed appearing in PCL text.</p> <p>The available values are:</p> <p>Off* On</p> <p>This setting enables the <LF>=<CR><LF> line termination mode in PCL as the default.</p>	1. Press Menu Up or Menu Down until you see:	Menus PCL Menu
	2. Press Item Up or Item Down until you see:	PCL Menu Line Terminat.
	3. Press Value Up or Value Down until you see:	Line Terminat. = New Value
	4. Press Enter . You will see:	PCL Menu Line Terminat.
	5. Press Online . You will see:	Ready

Table 1.12 Page 6 of 6

System Menu

The System Menu and its available items are described in Table 1.13.

Table 1.13 System Menu Items

Menu	Description	
System Menu	Allows you to set general printer features.	
	Menu Items	Description
	Language	Sets the language used for Control Panel display messages and generated reports.
	Paper Size	Sets the default paper size used in PostScript and PCL.
	Paper Type	Sets the default paper type used in PostScript and PCL.
	Page Policy	Allows the printer to automatically select an alternate paper size and/or type if the requested size and/or type is not loaded.
	Policy Timeout	Directs the printer as to how long to wait before taking the action defined by the setting of the Page Policy item.
	Print Quantity	Sets multiple copies of each page (not collated sets).
	Duplex	Enables or disables duplex printing for PostScript and PCL jobs (and appears only when the optional duplex unit is installed).
	Draft Mode	Enables or disables a reduced toner mode for draft printing (functions only if Resolution is set to <i>600x600</i> and XIE is set to <i>Off</i>).
	Edge-to-Edge	Enables or disables edge-to-edge printing in PCL.
XIE	Sets the default Xerox Image Enhancement image (resolution) enhancement mode.	

Table 1.13 Page 1 of 2

Table 1.13 System Menu Items (continued)

Menu	Description	
System Menu (continued)	Resolution	Sets the default resolution for PCL and PostScript jobs.
	Output Timeout	Determines how many seconds the system will wait after a bin is filled before directing output to an alternate bin (available only if optional Offset Catch Tray is installed).
	Output Offset	Enables or disables alternately offsetting output from jobs (available only if optional Offset Catch Tray is installed).
	Output Dest	Sets the default paper output destination for PCL and PostScript jobs (available only if optional Offset Catch Tray is installed).
	Print PS Errors	Controls the use of the PostScript built in error handler or debugger.
	Power Saver	Defines a period of inactivity after which time the printer will enter a low power state.
	Defaults	Sets the type of factory defaults to use when a "Factory Default" is performed.

Table 1.13 Page 2 of 2

Refer to Table 1.14 on page 1-44 for step-by-step instructions.

Table 1.14 System Menu Functions

Menu Item and Function	Keystrokes	Display
<p>Language</p> <p>Set the spoken language used for Control Panel display messages, Configuration Sheets, PCL Font Lists, Demo Pages, etc.</p> <p>The available values are:</p> <p>Deutsch English* Español Français Italiano Português(BRA) Русский (Russian)</p> <p> <i>For the new setting to take effect, you must restart the printer either by invoking the Print menu's Restart Printer item (see page 1-103) or by powering the printer off and on.</i></p> <p>The value of this setting is not affected by performing a "Factory Default" reset; therefore it does not have a default value apart from the initial value of <i>English</i> that is used when the printer is powered up for the first time.</p>	1. Press Menu Up or Menu Down until you see:	Menus System Menu
	2. Press Item Up or Item Down until you see:	System Menu Language
	3. Press Value Up or Value Down until you see:	Language = New Value
	4. Press Enter . You will see:	System Menu Language
	5. Press Online . You will see:	Ready (in the old language until a Restart is invoked)

Table 1.14 Page 1 of 10

Table 1.14 System Menu Functions (continued)

Menu Item and Function	Keystrokes	Display
Paper Size Set the default paper size used in PostScript and PCL. The available values are: Statmt(5.5x8.5) Exec(7.25x10.5) Letter(8.5x11)* Legal(8.5x14) Folio(8.5x13) A6(105x148) A5(148x210) A4(210x297)* B5-JIS(182x257) B5-ISO(176x250) Index(3x5) Com10(4.1x9.5) C5(162x229) DL(110x220) Monarc(3.8x7.5) Custom	1. Press Menu Up or Menu Down until you see:	Menus System Menu
	2. Press Item Up or Item Down until you see:	System Menu Paper Size
	3. Press Value Up or Value Down until you see:	Paper Size = New Value
	4. Press Enter . You will see:	System Menu Paper Size
	5. Press Online . You will see:	Ready
Paper Type Set the default paper type used in PostScript and PCL. The available values are: Plain* User type 1 Preprinted User type 2 Letterhead User type 3 Transparency User type 4 Prepunched User type 5 Labels Bond Recycled Color Cardstock (User types appear only if previously defined through CentreWare and if loaded.)	1. Press Menu Up or Menu Down until you see:	Menus System Menu
	2. Press Item Up or Item Down until you see:	System Menu Paper Type
	3. Press Value Up or Value Down until you see:	Paper Type = New Value
	4. Press Enter . You will see:	System Menu Paper Type
	5. Press Online . You will see:	Ready

Table 1.14 Page 2 of 10

Table 1.14 System Menu Functions (continued)

Menu Item and Function	Keystrokes	Display
Page Policy Allow the printer to automatically select an alternate paper size and/or type if the requested size and/or type is not loaded. The available values are: Off* Ignore Size Ignore Type Ignore Size/Typ	1. Press Menu Up or Menu Down until you see:	Menu System Menu
	2. Press Item Up or Item Down until you see:	System Menu Page Policy
	3. Press Value Up or Value Down until you see:	Page Policy = New Value
	4. Press Enter . You will see:	System Menu Page Policy
	5. Press Online . You will see:	Ready
<p>If the requested paper (size/type) is not installed, you will be prompted to load the requested paper. If the Page Policy is <i>Off</i> or the Page Policy does not satisfy the request, the printer will wait indefinitely until one of the following actions is taken:</p> <ul style="list-style-type: none"> • The job is cancelled from the Control Panel. • From the Control Panel, Value Up or Value Down is pressed to select an alternative tray to print from and then Enter is pressed (if Tray Sequence is not set to <i>Off</i>). • A sheet of paper of any size or type is inserted into the multi bypass feeder slot. • The proper paper (size/type) is loaded in the specified tray and the tray designation for type and size is corrected. See "Tray Menu" (page 1-22). <p>If a Page Policy is set, the printer will wait a time specified by the Policy Timeout (page 1-47) before invoking the Page Policy.</p>		
Table 1.14 Page 3 of 10		

Table 1.14 System Menu Functions (continued)

Menu Item and Function	Keystrokes	Display
<p>Policy Timeout</p> <p>Set how long the printer will wait before taking the action defined by the setting of Page Policy (page 1-46).</p> <p>The available values, in seconds, are:</p> <p>300 Seconds 180 Seconds 120 Seconds 60 Seconds 30 Seconds* 0 Seconds</p> <p>0 means immediately invoke Page Policy.</p>	1. Press Menu Up or Menu Down until you see:	Menus System Menu
	2. Press Item Up or Item Down until you see:	System Menu Policy Timeout
	3. Press Value Up or Value Down until you see:	Policy Timeout = New Value
	4. Press Enter . You will see:	System Menu Policy Timeout
	5. Press Online . You will see:	Ready
<p>Print Quantity</p> <p>Set the number of times each page is printed (uncollated). The setting is usually overridden by the job stream.</p> <p>The available values are:</p> <p>1* - 999</p> <p>The number of copies changes incrementally by 1 each time either Value Up or Value Down is pressed. Holding down Value Up or Value Down causes continuous scrolling through the number of copies.</p>	1. Press Menu Up or Menu Down until you see:	Menus System Menu
	2. Press Item Up or Item Down until you see:	System Menu Print Quantity
	3. Press Value Up or Value Down until you see:	Print Quantity = New Value
	4. Press Enter . You will see:	System Menu Print Quantity
	5. Press Online . You will see:	Ready

Table 1.14 Page 4 of 10

Table 1.14 System Menu Functions (continued)



Menu Item and Function	Keystrokes	Display
<p>Duplex</p> <p>Enable or disable duplex printing for PostScript and PCL jobs. The available values are:</p> <p>Off* Long Edge Short Edge</p> <p>This item is only available when the optional Duplex Module is installed.</p> <p> Control Panel settings for this feature may be overridden by the settings in the printer driver.</p>	1. Press Menu Up or Menu Down until you see:	Menus System Menu
	2. Press Item Up or Item Down until you see:	System Menu Duplex
	3. Press Value Up or Value Down until you see:	Duplex = New Value
	4. Press Enter . You will see:	System Menu Duplex
	5. Press Online . You will see:	Ready
<p>Draft Mode</p> <p>Enable or disable the reduced toner mode for draft printing. The available values are:</p> <p>Off* On</p> <p>Functions only when Resolution is set to 600x600 and XIE is set to <i>Off</i>.</p> <p>When set to <i>On</i>, the printer automatically reduces the amount of toner by up to two-thirds (and prints a draft-quality output).</p> <p> Control Panel settings for this feature may be overridden by the settings in the printer driver.</p>	1. Press Menu Up or Menu Down until you see:	Menus System Menu
	2. Press Item Up or Item Down until you see:	System Menu Draft Mode
	3. Press Value Up or Value Down until you see:	Draft Mode = New Value
	4. Press Enter . You will see:	System Menu Draft Mode
	5. Press Online . You will see:	Ready

Table 1.14 Page 5 of 10

Table 1.14 System Menu Functions (continued)



Menu Item and Function	Keystrokes	Display
<p>Edge-to-Edge</p> <p>Enable or disable edge to edge printing for PCL jobs. The available values are:</p> <p>Off* On</p> <p> Control Panel settings for this feature may be overridden by the settings in the printer driver.</p>	1. Press Menu Up or Menu Down until you see:	Menus System Menu
	2. Press Item Up or Item Down until you see:	System Menu Edge-to-Edge
	3. Press Value Up or Value Down until you see:	Edge-to-Edge = New Value
	4. Press Enter . You will see:	System Menu Edge-to-Edge
	5. Press Online . You will see:	Ready
<p>XIE</p> <p>Set the default Xerox Image Enhancement (resolution) mode. The available values are:</p> <p>Off* On</p> <p> This item functions only when Resolution is set to 600x600 and Draft Mode is set to Off.</p>	1. Press Menu Up or Menu Down until you see:	Menus System Menu
	2. Press Item Up or Item Down until you see:	System Menu XIE
	3. Press Value Up or Value Down until you see:	XIE = New Value
	4. Press Enter . You will see:	System Menu XIE
	5. Press Online . You will see:	Ready

Table 1.14 Page 6 of 10

Table 1.14 System Menu Functions (continued)

Menu Item and Function	Keystrokes	Display
<p>Resolution</p> <p>Select the default resolution in PostScript and PCL emulations. The available values are:</p> <p>600x600* 1200x1200</p> <p>PCL 5e is always set to 600x600 regardless of the value for this item.</p> <p> <i>Control Panel settings for this feature may be overridden by the settings in the printer driver.</i></p>	1. Press Menu Up or Menu Down until you see:	Menus System Menu
	2. Press Item Up or Item Down until you see:	System Menu Resolution
	3. Press Value Up or Value Down until you see:	Resolution = New Value
	4. Press Enter . You will see:	System Menu Resolution
	5. Press Online . You will see:	Ready
<p>Output Timeout</p> <p>Determine whether or not the printer will select an alternate bin when the selected output bin becomes full. The available values are:</p> <p>Off* On</p> <p>This item requires the optional Offset Catch Tray.</p>	1. Press Menu Up or Menu Down until you see:	Menus System Menu
	2. Press Item Up or Item Down until you see:	System Menu Output Timeout
	3. Press Value Up or Value Down until you see:	Output Timeout = New Value
	4. Press Enter . You will see:	System Menu Output Timeout
	5. Press Online . You will see:	Ready

Table 1.14 Page 7 of 10

Table 1.14 System Menu Functions (continued)

Menu Item and Function	Keystrokes	Display
<p>Output Offset</p> <p>Enable or disable alternately offsetting output from jobs. The available values are:</p> <p>On* Off</p> <p>This item requires the optional Offset Catch Tray.</p>	1. Press Menu Up or Menu Down until you see:	Menus System Menu
	2. Press Item Up or Item Down until you see:	System Menu Output Offset
	3. Press Value Up or Value Down until you see:	Output Offset = New Value
	4. Press Enter . You will see:	System Menu Output Offset
	5. Press Online . You will see:	Ready
<p>Output Dest</p> <p>Set the default paper output destination. The available values are:</p> <p>Standard Bin* Offset Bin</p> <p>This item requires the optional Offset Catch Tray.</p> <p>For more information on printing to the Offset Catch Tray, refer to the section "Configuring Output Offsetting" (page 1-125).</p> <p> <i>Control Panel settings for this feature may be overridden by the settings in the printer driver.</i></p>	1. Press Menu Up or Menu Down until you see:	Menus System Menu
	2. Press Item Up or Item Down until you see:	System Menu Output Dest
	3. Press Value Up or Value Down until you see:	Output Dest = New Value
	4. Press Enter . You will see:	System Menu Output Dest
	5. Press Online . You will see:	Ready

Table 1.14 Page 8 of 10

Table 1.14 System Menu Functions (continued)

Menu Item and Function	Keystrokes	Display
<p>Print PS Errors</p> <p>Set to control the use of the built in error handler or debugger in the PostScript interpreter.</p> <p>The available values are:</p> <p>Off* On</p> <p>When <i>On</i>, PostScript error information is printed. When <i>Off</i>, the job flushes and no information is provided.</p>	1. Press Menu Up or Menu Down until you see:	Menus System Menu
	2. Press Item Up or Item Down until you see:	System Menu Print PS Errors
	3. Press Value Up or Value Down until you see:	Print PS Errors= New Value
	4. Press Enter . You will see:	System Menu Print PS Errors
	5. Press Online . You will see:	Ready
<p>Power Saver</p> <p>Set the time the printer will remain idle before power saver mode is activated.</p> <p>The available values, in minutes, are:</p> <p>180 Minutes 120 Minutes 90 Minutes 60 Minutes* 30 Minutes 15 Minutes Off (never enter power saver mode)</p>	1. Press Menu Up or Menu Down until you see:	Menus System Menu
	2. Press Item Up or Item Down until you see:	System Menu Power Saver
	3. Press Value Up or Value Down until you see:	Power Saver = New Value
	4. Press Enter . You will see:	System Menu Power Saver
	5. Press Online . You will see:	Ready

Table 1.14 Page 9 of 10

Table 1.14 System Menu Functions (continued)

Menu Item and Function	Keystrokes	Display
<p>Defaults</p> <p>Sets default units. This is not changed when a “Factory Default” is performed.</p> <p>The available values are:</p> <ul style="list-style-type: none"> • Inches (factory default for 110V configuration) • Millimeters (factory default for 220V configuration) <p>The following defaults are affected by changing this setting:</p> <ul style="list-style-type: none"> • System Menu>Paper Size • PCL Menu>Form Length • Tray Menu>MBF Size • Tray Menu>Custom Size • Tray Menu>Envelope Size (if envelope feeder is installed). 	1. Press Menu Up or Menu Down until you see:	Menus System Menu
	2. Press Item Up or Item Down until you see:	System Menu Defaults
	3. Press Value Up or Value Down until you see:	Defaults = New Value
	4. Press Enter . You will see:	System Menu Defaults
	5. Press Online . You will see:	Ready

Table 1.14 Page 10 of 10

Parallel Menu

The Parallel Menu and its available items are described in Table 1.15.

Table 1.15 Parallel Menu Items

Menu	Description	
Parallel Menu	Allows you to set options for the parallel port connection.	
	Menu Items	Description
	Port Enable	Enables or disables the parallel port.
	Port Timeout	Sets the time for determining when to end an incomplete print job and poll the next port in the polling sequence.
	Parallel PDL	Sets the default emulation (page description language) for the parallel port.
	Binary PS	Enables or disables the binary mode of PostScript.
	Bidirectional	Enables or disables bidirectional communications through the parallel port.

Refer to Table 1.16 on page 1-55 for step-by-step instructions.

Table 1.16 Parallel Menu Functions

Menu Item and Function	Keystrokes	Display
<p>Port Enable</p> <p>Enable or disable the parallel port.</p> <p>The available values are:</p> <p>On* Off</p> <p> <i>For the new setting to take effect, you must restart the printer either by invoking the Print menu's Restart Printer item (see page 1-103) or by powering the printer off and on.</i></p>	1. Press Menu Up or Menu Down until you see:	Menus Parallel Menu
	2. Press Item Up or Item Down until you see:	Parallel Menu Port Enable
	3. Press Value Up or Value Down until you see:	Port Enable = New Value
	4. Press Enter . You will see:	Parallel Menu Port Enable
	5. Press Online . You will see:	Ready
<p>Port Timeout</p> <p>Set the time for determining when to end an incomplete print job and poll the next port in the polling sequence.</p> <p>The available values are:</p> <p>5 - 300 seconds (30*)</p> <p>This item also causes an implicit job end such as Control D in PostScript or <ESC> E in PCL, and invokes the emulation functions associated with this action (e.g., formfeed, reset, etc.).</p> <p>The time changes incrementally by 1 second each time either Value Up or Value Down is pressed. Holding down Value Up or Value Down causes continuous scrolling through the values.</p>	1. Press Menu Up or Menu Down until you see:	Menus Parallel Menu
	2. Press Item Up or Item Down until you see:	Parallel Menu Port Timeout
	3. Press Value Up or Value Down until you see:	Port Timeout = New Value
	4. Press Enter . You will see:	Parallel Menu Port Timeout
	5. Press Online . You will see:	Ready

Table 1.16 Page 1 of 3

Table 1.16 Parallel Menu Functions (continued)

Menu Item and Function	Keystrokes	Display
Parallel PDL Set the default emulation (page description language) for the parallel port. The available values are: Auto* PCL PostScript When set to <i>Auto</i> , the printer will sense the PDL for each job and automatically set the PDL accordingly.	1. Press Menu Up or Menu Down until you see:	Menus Parallel Menu
	2. Press Item Up or Item Down until you see:	Parallel Menu Parallel PDL
	3. Press Value Up or Value Down until you see:	Parallel PDL = New Value
	4. Press Enter . You will see:	Parallel Menu Parallel PDL
	5. Press Online . You will see:	Ready
Binary PS Enable or disable the binary mode of PostScript for print jobs received on this port. The available values are: On Off*	1. Press Menu Up or Menu Down until you see:	Menus Parallel Menu
	2. Press Item Up or Item Down until you see:	Parallel Menu Binary PS
	3. Press Value Up or Value Down until you see:	Binary PS = New Value
	4. Press Enter . You will see:	Parallel Menu Binary PS
	5. Press Online . You will see:	Ready

Table 1.16 Page 2 of 3

Table 1.16 Parallel Menu Functions (continued)

Menu Item and Function	Keystrokes	Display
Bidirectional Enable or disable bidirectional communications through the parallel port. The available values are: On* Off	1. Press Menu Up or Menu Down until you see:	Menus Parallel Menu
	2. Press Item Up or Item Down until you see:	Parallel Menu Bidirectional
	3. Press Value Up or Value Down until you see:	Bidirectional = New Value
	4. Press Enter . You will see:	Parallel Menu Bidirectional
	5. Press Online . You will see:	Ready
Table 1.16 Page 3 of 3		

Serial Menu

The Serial Menu and its available items are described in Table 1.17.

Table 1.17 Serial Menu Items

Menu	Description	
Serial Menu	Allows you to set options for the serial port connection (and appears only if the optional serial port is installed).	
	Menu Items	Description
	Port Enable	Enables or disables the serial port.
	Port Timeout	Sets the time for determining when to end an incomplete print job and poll the next port in the polling sequence.
	Serial PDL	Sets the default emulation (page description language) for the serial port.
	Flow Control	Sets the handshaking flow control parameters for the serial port.
	Baud Rate	Sets the baud rate for the serial port.
	Binary PS	Enables or disables the binary mode of PostScript.

Refer to Table 1.18 on page 1-59 for step-by-step instructions.

Table 1.18 Serial Menu Functions

Menu Item and Function	Keystrokes	Display
<p>Port Enable</p> <p>Enable or disable the serial port.</p> <p>The available values are:</p> <p>On* Off</p> <p> <i>For the new setting to take effect, you must restart the printer either by invoking the Print menu's Restart Printer item (see page 1-103) or by powering the printer off and on.</i></p>	1. Press Menu Up or Menu Down until you see:	Menus Serial Menu
	2. Press Item Up or Item Down until you see:	Serial Menu Port Enable
	3. Press Value Up or Value Down until you see:	Port Enable = New Value
	4. Press Enter . You will see:	Serial Menu Port Enable
	5. Press Online . You will see:	Ready
<p>Port Timeout</p> <p>Set the time for determining when to end an incomplete print job and poll the next port in the polling sequence.</p> <p>The available values are:</p> <p>5 - 300 seconds (30*)</p> <p>This item also causes an implicit job end such as Control D in PostScript or <ESC> E in PCL, and invokes the emulation functions associated with this action (e.g., formfeed, reset, etc.).</p> <p>The time changes incrementally by 1 second each time either Value Up or Value Down is pressed. Holding down Value Up or Value Down causes continuous scrolling through the values.</p>	1. Press Menu Up or Menu Down until you see:	Menus Serial Menu
	2. Press Item Up or Item Down until you see:	Serial Menu Port Timeout
	3. Press Value Up or Value Down until you see:	Port Timeout = New Value
	4. Press Enter . You will see:	Serial Menu Port Timeout
	5. Press Online . You will see:	Ready

Table 1.18 Page 1 of 3

Table 1.18 Serial Menu Functions (continued)

Menu Item and Function	Keystrokes	Display
Serial PDL Set the default emulation (page description language) for the serial port. The available values are: Auto* PCL Postscript When set to <i>Auto</i> , the printer will sense the PDL for each job and automatically set the PDL accordingly.	1. Press Menu Up or Menu Down until you see:	Menus Serial Menu
	2. Press Item Up or Item Down until you see:	Serial Menu Serial PDL
	3. Press Value Up or Value Down until you see:	Serial PDL = New Value
	4. Press Enter . You will see:	Serial Menu Serial PDL
	5. Press Online . You will see:	Ready
Flow Control Set the handshaking flow control parameters for the serial port. The available values are: XON/XOFF Robust XON/XOFF Hardware*	1. Press Menu Up or Menu Down until you see:	Menus Serial Menu
	2. Press Item Up or Item Down until you see:	Serial Menu Flow Control
	3. Press Value Up or Value Down until you see:	Flow Control = New Value
	4. Press Enter . You will see:	Serial Menu Flow Control
	5. Press Online . You will see:	Ready

Table 1.18 Page 2 of 3

Table 1.18 Serial Menu Functions (continued)

Menu Item and Function	Keystrokes	Display
Baud Rate Set the baud rate for the serial port. The available values are: 115200 57600 38400 28800 19200 9600* 4800 2400 1200 600	1. Press Menu Up or Menu Down until you see:	Menus Serial Menu
	2. Press Item Up or Item Down until you see:	Serial Menu Baud Rate
	3. Press Value Up or Value Down until you see:	Baud Rate = New Value
	4. Press Enter . You will see:	Serial Menu Baud Rate
	5. Press Online . You will see:	Ready
Binary PS Enable or disable the binary mode of PostScript for print jobs received on this port. The available values are: On Off*	1. Press Menu Up or Menu Down until you see:	Menus Serial Menu
	2. Press Item Up or Item Down until you see:	Serial Menu Binary PS
	3. Press Value Up or Value Down until you see:	Binary PS = New Value
	4. Press Enter . You will see:	Serial Menu Binary PS
	5. Press Online . You will see:	Ready
Table 1.18 Page 3 of 3		

USB Menu

The USB Menu and its available items are described in Table 1.19.

Table 1.19 USB Menu Items

Menu	Description	
USB Menu	Allows you to set options for the USB port connection.	
	Menu Items	Description
	Port Enable	Enables or disables the USB port.
	Port Timeout	Sets the time for determining when to end an incomplete print job and poll the next port in the polling sequence.
	USB PDL	Sets the default emulation (page description language) for the USB port.
	Binary PS	Enables or disables the binary mode of PostScript.

Refer to Table 1.20 on page 1-63 for step-by-step instructions.

Table 1.20 USB Menu Functions

Menu Item and Function	Keystrokes	Display
<p>Port Enable</p> <p>Enable or disable the USB port.</p> <p>The available values are:</p> <p>On* Off</p> <p> <i>For the new setting to take effect, you must restart the printer either by invoking the Print menu's Restart Printer item (see page 1-103) or by powering the printer off and on.</i></p>	1. Press Menu Up or Menu Down until you see:	Menus USB Menu
	2. Press Item Up or Item Down until you see:	USB Menu Port Enable
	3. Press Value Up or Value Down until you see:	Port Enable = New Value
	4. Press Enter . You will see:	USB Menu Port Enable
	5. Press Online . You will see:	Ready
<p>Port Timeout</p> <p>Set the time for determining when to end an incomplete print job and poll the next port in the polling sequence.</p> <p>The available values are:</p> <p>5 - 300 seconds (30*)</p> <p>This item also causes an implicit job end such as Control D in PostScript or <ESC> E in PCL, and invokes the emulation functions associated with this action (e.g., formfeed, reset, etc.).</p> <p>The time changes incrementally by 1 second each time either Value Up or Value Down is pressed. Holding down Value Up or Value Down causes continuous scrolling through the values.</p>	1. Press Menu Up or Menu Down until you see:	Menus USB Menu
	2. Press Item Up or Item Down until you see:	USB Menu Port Timeout
	3. Press Value Up or Value Down until you see:	Port Timeout = New Value
	4. Press Enter . You will see:	USB Menu Port Timeout
	5. Press Online . You will see:	Ready

Table 1.20 Page 1 of 2

Table 1.20 USB Menu Functions (continued)

Menu Item and Function	Keystrokes	Display
USB PDL Set the default emulation (page description language) for the USB port. The available values are: Auto* PCL Postscript When set to <i>Auto</i> , the printer will sense the PDL for each job and automatically set the PDL accordingly.	1. Press Menu Up or Menu Down until you see:	Menus USB Menu
	2. Press Item Up or Item Down until you see:	USB Menu USB PDL
	3. Press Value Up or Value Down until you see:	USB PDL = New Value
	4. Press Enter . You will see:	USB Menu USB PDL
	5. Press Online . You will see:	Ready
Binary PS Enable or disable the binary mode of PostScript for print jobs received on this port. The available values are: On Off*	1. Press Menu Up or Menu Down until you see:	Menus USB Menu
	2. Press Item Up or Item Down until you see:	USB Menu Binary PS
	3. Press Value Up or Value Down until you see:	Binary PS = New Value
	4. Press Enter . You will see:	USB Menu Binary PS
	5. Press Online . You will see:	Ready

Table 1.20 Page 2 of 2

Ethernet Menu

The Ethernet Menu and its available items are described in Table 1.21. This menu appears only on network capable printers if the Token Ring option is not installed.

Table 1.21 Ethernet Menu Items

Menu	Description	
Ethernet Menu	Allows you to set options for the Ethernet port connection.	
	Menu Items	Description
	LPR Enable	Enables or disables the Ethernet LPR protocol.
	LPR Banner	Enables or disables the LPR banner sheet.
	LPR PDL	Sets the default emulation (page description language) for the Ethernet LPR protocol.
	LPR Binary PS	Enables or disables the LPR binary mode of PostScript.
	DLC/LLC Enable	Enables or disables the Ethernet DLC/LLC protocol.
	DLC/LLC PDL	Sets the default emulation (page description language) for the Ethernet DLC protocol.
	DLC/LLC Bin PS	Enables or disables the DLC/LLC binary mode of PostScript.
	NetBEUI Enable	Enables or disables the Ethernet NetBEUI interface.
	NetBEUI PDL	Sets the default emulation (page description language) for the Ethernet NetBEUI interface.
	NetBEUI Bin PS	Enables or disables the NetBEUI binary mode of PostScript.
	AppSocket Enabl	Enables or disables the Ethernet AppSocket interface.
	AppSocket PDL	Sets the default emulation (page description language) for the Ethernet AppSocket interface.
AppSocket Bin PS	Enables or disables the AppSocket binary mode of PostScript.	

Table 1.21 Page 1 of 2

Table 1.21 Ethernet Menu Items *(continued)*

Menu	Description	
Ethernet Menu (continued)	ETalk Enable	Enables or disables the Ethernet EtherTalk protocol.
	HTTP Enable	Enables or disables the Ethernet HTTP Server protocol.
	IP Address Res.	Sets the method used to resolve (Res) the IP address, including subnet mask and default gateway.
	IP Address	Sets the four byte IP address.
	Sub Net Mask	Sets the four byte Subnet Mask address.
	Default Gateway	Sets the four byte Default Gateway address.
	Port Timeout	Sets the time for determining when to end an incomplete print job and poll the next port in the polling sequence.
	Speed	Sets the speed of the 10/100 Ethernet interface.

Table 1.21 Page 2 of 2

Refer to Table 1.22 on page 1-67 for step-by-step instructions.

Table 1.22 Ethernet Menu Functions

Menu Item and Function	Keystrokes	Display
LPR Enable Enable or disable the Ethernet LPR protocol. The available values are: On* Off	1. Press Menu Up or Menu Down until you see:	Menus Ethernet Menu
	2. Press Item Up or Item Down until you see:	Ethernet Menu LPR Enable
	3. Press Value Up or Value Down until you see:	LPR Enable = New Value
	4. Press Enter . You will see:	Ethernet Menu LPR Enable
	5. Press Online . You will see:	Ready
LPR Banner Enable or disable the LPR banner sheet. The available values are: On* Off	1. Press Menu Up or Menu Down until you see:	Menus Ethernet Menu
	2. Press Item Up or Item Down until you see:	Ethernet Menu LPR Banner
	3. Press Value Up or Value Down until you see:	LPR Banner = New Value
	4. Press Enter . You will see:	Ethernet Menu LPR Banner
	5. Press Online . You will see:	Ready

Table 1.22 Page 1 of 12

Table 1.22 Ethernet Menu Functions (continued)

Menu Item and Function	Keystrokes	Display
LPR PDL Set the default emulation (page description language) for the Ethernet LPR protocol. The available values are: Auto* PCL PostScript When set to <i>Auto</i> , the printer will sense the PDL for each job and automatically set the PDL accordingly.	1. Press Menu Up or Menu Down until you see:	Menus Ethernet Menu
	2. Press Item Up or Item Down until you see:	Ethernet Menu LPR PDL
	3. Press Value Up or Value Down until you see:	LPR PDL = New Value
	4. Press Enter . You will see:	Ethernet Menu LPR PDL
	5. Press Online . You will see:	Ready
LPR Binary PS Enable or disable the LPR binary mode of PostScript. The available values are: On Off*	1. Press Menu Up or Menu Down until you see:	Menus Ethernet Menu
	2. Press Item Up or Item Down until you see:	Ethernet Menu LPR Binary PS
	3. Press Value Up or Value Down until you see:	LPR Binary PS = New Value
	4. Press Enter . You will see:	Ethernet Menu LPR Binary PS
	5. Press Online . You will see:	Ready

Table 1.22 Page 2 of 12

Table 1.22 Ethernet Menu Functions (continued)

Menu Item and Function	Keystrokes	Display
DLC/LLC Enable Enable or disable the DLC/LLC protocol. The available values are: On* Off	1. Press Menu Up or Menu Down until you see:	Menus Ethernet Menu
	2. Press Item Up or Item Down until you see:	Ethernet Menu DLC/LLC Enable
	3. Press Value Up or Value Down until you see:	DLC/LLC Enable = New Value
	4. Press Enter . You will see:	Ethernet Menu DLC/LLC Enable
	5. Press Online . You will see:	Ready
DLC/LLC PDL Set the default emulation (page description language) for the DLC/LLC protocol. The available values are: Auto* PCL PostScript When set to <i>Auto</i> , the printer will sense the PDL for each job and automatically set the PDL accordingly.	1. Press Menu Up or Menu Down until you see:	Menus Ethernet Menu
	2. Press Item Up or Item Down until you see:	Ethernet Menu DLC/LLC PDL
	3. Press Value Up or Value Down until you see:	DLC/LLC PDL = New Value
	4. Press Enter . You will see:	Ethernet Menu DLC/LLC PDL
	5. Press Online . You will see:	Ready

Table 1.22 Page 3 of 12

Table 1.22 Ethernet Menu Functions (continued)

Menu Item and Function	Keystrokes	Display
DLC/LLC Bin PS Enable or disable the DLC/LLC binary mode of PostScript. The available values are: On Off*	1. Press Menu Up or Menu Down until you see:	Menus Ethernet Menu
	2. Press Item Up or Item Down until you see:	Ethernet Menu DLC/LLC Bin PS
	3. Press Value Up or Value Down until you see:	DLC/LLC Bin PS = New Value
	4. Press Enter . You will see:	Ethernet Menu DLC/LLC Bin PS
	5. Press Online . You will see:	Ready
NetBEUI Enable Enable or disable the NetBEUI protocol. The available values are: On* Off	1. Press Menu Up or Menu Down until you see:	Menus Ethernet Menu
	2. Press Item Up or Item Down until you see:	Ethernet Menu NetBEUI Enable
	3. Press Value Up or Value Down until you see:	NetBEUI Enable = New Value
	4. Press Enter . You will see:	Ethernet Menu NetBEUI Enable
	5. Press Online . You will see:	Ready

Table 1.22 Page 4 of 12

Table 1.22 Ethernet Menu Functions (continued)

Menu Item and Function	Keystrokes	Display
NetBEUI PDL Set the default emulation (page description language) for the NetBEUI protocol. The available values are: Auto* PCL PostScript When set to <i>Auto</i> , the printer will sense the PDL for each job and automatically set the PDL accordingly.	1. Press Menu Up or Menu Down until you see:	Menus Ethernet Menu
	2. Press Item Up or Item Down until you see:	Ethernet Menu NetBEUI PDL
	3. Press Value Up or Value Down until you see:	NetBEUI PDL = New Value
	4. Press Enter . You will see:	Ethernet Menu NetBEUI PDL
	5. Press Online . You will see:	Ready
NetBEUI Bin PS Enable or disable the NetBEUI binary mode of PostScript. The available values are: On Off*	1. Press Menu Up or Menu Down until you see:	Menus Ethernet Menu
	2. Press Item Up or Item Down until you see:	Ethernet Menu NetBEUI Bin PS
	3. Press Value Up or Value Down until you see:	NetBEUI Bin PS = New Value
	4. Press Enter . You will see:	Ethernet Menu NetBEUI Bin PS
	5. Press Online . You will see:	Ready

Table 1.22 Page 5 of 12

Table 1.22 Ethernet Menu Functions (continued)

Menu Item and Function	Keystrokes	Display
AppSocket Enabl Enable or disable the Ethernet AppSocket protocol. The AppSocket in the printer supports Ports 2000, 9100, and 2501. The available values are: On* Off	1. Press Menu Up or Menu Down until you see:	Menus Ethernet Menu
	2. Press Item Up or Item Down until you see:	Ethernet Menu AppSocket Enabl
	3. Press Value Up or Value Down until you see:	AppSocket Enabl= New Value
	4. Press Enter . You will see:	Ethernet Menu AppSocket Enabl
	5. Press Online . You will see:	Ready
AppSocket PDL Set the default emulation (page description language) for the Ethernet AppSocket protocol. The available values are: Auto* PCL PostScript When set to <i>Auto</i> , the printer will sense the PDL for each job and automatically set the PDL accordingly.	1. Press Menu Up or Menu Down until you see:	Menus Ethernet Menu
	2. Press Item Up or Item Down until you see:	Ethernet Menu AppSocket PDL
	3. Press Value Up or Value Down until you see:	AppSocket PDL = New Value
	4. Press Enter . You will see:	Ethernet Menu AppSocket PDL
	5. Press Online . You will see:	Ready

Table 1.22 Page 6 of 12

Table 1.22 Ethernet Menu Functions (continued)

Menu Item and Function	Keystrokes	Display
AppSocket Bin PS Enable or disable the AppSocket binary mode of PostScript. The available values are: On Off*	1. Press Menu Up or Menu Down until you see:	Menus Ethernet Menu
	2. Press Item Up or Item Down until you see:	Ethernet Menu AppSocket Bin PS
	3. Press Value Up or Value Down until you see:	AppSocket Bin PS= New Value
	4. Press Enter . You will see:	Ethernet Menu AppSocket Bin PS
	5. Press Online . You will see:	Ready
ETalk Enable Enable or disable the Ethernet EtherTalk protocol. The available values are: On* Off	1. Press Menu Up or Menu Down until you see:	Menus Ethernet Menu
	2. Press Item Up or Item Down until you see:	Ethernet Menu ETalk Enable
	3. Press Value Up or Value Down until you see:	ETalk Enable = New Value
	4. Press Enter . You will see:	Ethernet Menu ETalk Enable
	5. Press Online . You will see:	Ready

Table 1.22 Page 7 of 12

Table 1.22 Ethernet Menu Functions (continued)

Menu Item and Function	Keystrokes	Display
HTTP Enable Enable or disable the Ethernet HTTP Server protocol. The available values are: On* Off	1. Press Menu Up or Menu Down until you see:	Menus Ethernet Menu
	2. Press Item Up or Item Down until you see:	Ethernet Menu HTTP Enable
	3. Press Value Up or Value Down until you see:	HTTP Enable = New Value
	4. Press Enter . You will see:	Ethernet Menu HTTP Enable
	5. Press Online . You will see:	Ready
IP Address Res. When set to <i>Static</i> , values can be set for IP Address, Sub Net Mask and Default Gateway. The available values are: Static BOOTP/RARP DHCP*	1. Press Menu Up or Menu Down until you see:	Menus Ethernet Menu
	2. Press Item Up or Item Down until you see:	Ethernet Menu IP Address Res.
	3. Press Value Up or Value Down until you see:	IP Address Res. = New Value
	4. Press Enter . You will see:	Ethernet Menu IP Address Res.
	5. Press Online . You will see:	Ready

Table 1.22 Page 8 of 12

Table 1.22 Ethernet Menu Functions (continued)

Menu Item and Function	Keystrokes	Display
<p>IP Address</p> <p> <i>This item appears only if IP Address Res is set to Static.</i></p> <p>Set the four byte IP address.</p> <p>The available values are: xxx.xxx.xxx.xxx (where xxx = 000 to 255)</p> <p>For this item (after Step 3), Item Up moves the cursor to the right through the displayed IP address and Item Down moves the cursor to the left. This allows you to change characters within the string rather than having to reenter the entire string.</p>	1. Press Menu Up or Menu Down until you see:	Menus Ethernet Menu
	2. Press Item Up or Item Down until you see:	Ethernet Menu IP Address
	3. Press Value Up or Value Down . You will see:	IP Address = xxx.xxx.xxx.xxx
	4. Press Value Up or Value Down to change the value of the character above the cursor. The value is incremented or decremented by 1 each time the key is pressed. Holding down Value Up or Value Down causes continuous scrolling through the values.	IP Address = xxx.xxx.xxx.xxx
	5. To change other characters in the IP address, press Item Up or Item Down to scroll right or left respectively through the character string, then press Value Up or Value Down to change the value of the character above the cursor (as in Step 4).	IP Address = xxx.xxx.xxx.xxx
	6. When you have completed setting the IP address, press Enter . You will see:	Ethernet Menu IP Address
	7. Press Online . You will see:	Ready
	8. Restart printer or power off/on.	

Table 1.22 Page 9 of 12

Table 1.22 Ethernet Menu Functions (continued)

Menu Item and Function	Keystrokes	Display
<p>Sub Net Mask</p> <p> <i>This item appears only if IP Address Res is set to Static.</i></p> <p>Set the four byte Subnet Mask address.</p> <p>The available values are:</p> <p>xxx.xxx.xxx.xxx (where xxx = 000 to 255)</p> <p>For this item (after Step 3), Item Up moves the cursor to the right through the displayed Subnet Mask address and Item Down moves the cursor to the left. This allows you to change characters within the string rather than having to reenter the entire string.</p>	1. Press Menu Up or Menu Down until you see:	Menus Ethernet Menu
	2. Press Item Up or Item Down until you see:	Ethernet Menu Sub Net Mask
	3. Press Value Up or Value Down . You will see:	Sub Net Mask = xxx.xxx.xxx.xxx
	4. Press Value Up or Value Down to change the value of the character above the cursor. The value is incremented or decremented by 1 each time the key is pressed. Holding down Value Up or Value Down causes continuous scrolling through the values.	Sub Net Mask = xxx.xxx.xxx.xxx
	5. To change other characters in the Subnet Mask address, press Item Up or Item Down to scroll right or left respectively through the character string, then press Value Up or Value Down to change the value of the character above the cursor (as in Step 4).	Sub Net Mask = xxx.xxx.xxx.xxx
	6. When you have completed setting the Subnet Mask address, press Enter . You will see:	Ethernet Menu Sub Net Mask
	7. Press Online . You will see:	Ready
	8. Restart printer or power off/on.	

Table 1.22 Page 10 of 12

Table 1.22 Ethernet Menu Functions (continued)

Menu Item and Function	Keystrokes	Display
<p>Default Gateway</p> <p> <i>This item appears only if IP Address Res is set to Static.</i></p> <p>Set the four byte Default Gateway address.</p> <p>The available values are:</p> <p>xxx.xxx.xxx.xxx (where xxx = 000 to 255)</p> <p>For this item (after Step 3), Item Up moves the cursor to the right through the displayed Default Gateway address and Item Down moves the cursor to the left. This allows you to change characters within the string rather than having to reenter the entire string.</p> <p>With the cursor displayed under a character, Value Up increments the value of that character and Value Down decrements the value.</p>	1. Press Menu Up or Menu Down until you see:	Menus Ethernet Menu
	2. Press Item Up or Item Down until you see:	Ethernet Menu Default Gateway
	3. Press Value Up or Value Down . You will see:	Default Gateway= xxx.xxx.xxx.xxx
	4. Press Value Up or Value Down to change the value of the character above the cursor. The value is incremented or decremented by 1 each time the key is pressed. Holding down Value Up or Value Down causes continuous scrolling through the values.	Default Gateway= xxx.xxx.xxx.xxx
	5. To change other characters in the Default Gateway address, press Item Up or Item Down to scroll right or left respectively through the character string, then press Value Up or Value Down to change the value of the character above the cursor (as in Step 4).	Default Gateway= xxx.xxx.xxx.xxx
	6. When you have completed setting the Default Gateway address, press Enter . You will see:	Ethernet Menu Default Gateway
	7. Press Online . You will see:	Ready
	8. Restart printer or power off/on.	

Table 1.22 Page 11 of 12

Table 1.22 Ethernet Menu Functions (continued)

Menu Item and Function	Keystrokes	Display
<p>Port Timeout</p> <p>Set the time for determining when to end an incomplete print job and poll the next port in the polling sequence.</p> <p>The available values are:</p> <p>5 - 300 seconds (60*)</p> <p>This item also causes an implicit job end such as Control D in PostScript or <ESC> E in PCL, and invokes the emulation functions associated with this action (e.g., formfeed, reset, etc.).</p> <p>The time changes incrementally by 1 second each time either Value Up or Value Down is pressed. Holding down Value Up or Value Down causes continuous scrolling through the values.</p>	1. Press Menu Up or Menu Down until you see:	Menus Ethernet Menu
	2. Press Item Up or Item Down until you see:	Ethernet Menu Port Timeout
	3. Press Value Up or Value Down until you see:	Port Timeout = New Value
	4. Press Enter . You will see:	Ethernet Menu Port Timeout
	5. Press Online . You will see:	Ready
<p>Speed</p> <p>Set the speed of the 10/100 Ethernet interface (does not appear if the 10Base2 option is installed).</p> <p>The available values are:</p> <p>Auto* 10/HALF 10/FULL 100/HALF 100/FULL</p> <p>HALF = half duplex Ethernet mode FULL = full duplex Ethernet mode</p>	1. Press Menu Up or Menu Down until you see:	Menus Ethernet Menu
	2. Press Item Up or Item Down until you see:	Ethernet Menu Speed
	3. Press Value Up or Value Down until you see:	Speed = New Value
	4. Press Enter . You will see:	Ethernet Menu Speed
	5. Press Online . You will see:	Ready

Token Ring Menu

The Token Ring Menu and its available items are described in Table 1.23. This menu appears only on network capable printers with the Token Ring option installed.

Table 1.23 Token Ring Menu Items

Menu	Description	
Token Ring Menu	Allows you to set options for the Token Ring port connection (and appears only if the optional Token Ring interface is installed).	
	Menu Items	Description
	LPR Enable	Enables or disables the Token Ring LPR protocol.
	LPR Banner	Enables or disables the LPR banner sheet.
	LPR PDL	Sets the default emulation (page description language) for the Token Ring LPR protocol.
	LPR Binary PS	Enables or disables the LPR binary mode of PostScript.
	DLC/LLC Enable	Enables or disables the Token Ring DLC/LLC protocol.
	DLC/LLC PDL	Sets the default emulation (page description language) for the Token Ring DLC protocol.
	DLC/LLC Bin PS	Enables or disables the DLC/LLC binary mode of PostScript.
	NetBEUI Enable	Enables or disables the Token Ring NetBEUI interface.
	NetBEUI PDL	Sets the default emulation (page description language) for the Token Ring NetBEUI interface.
	NetBEUI Bin PS	Enables or disables the NetBEUI binary mode of PostScript.
	AppSocket Enabl	Enables or disables the Token Ring AppSocket interface.
	AppSocket PDL	Sets the default emulation (page description language) for the Token Ring AppSocket interface.
AppSocket Bin PS	Enables or disables the AppSocket binary mode of PostScript.	

Table 1.23 Page 1 of 2

Table 1.23 Token Ring Menu Items *(continued)*

Menu	Description	
Token Ring Menu (continued)	TTalk Enable	Enables or disables the Token Ring TokenTalk protocol.
	HTTP Enable	Enables or disables the Token Ring HTTP Server protocol.
	IP Address Res.	Sets the method used to resolve (Res) the IP address, including subnet mask and default gateway.
	IP Address	Sets the four byte IP address.
	Sub Net Mask	Sets the four byte Sub Net Mask address.
	Default Gateway	Sets the four byte Default Gateway address.
	Port Timeout	Sets the time for determining when to end an incomplete print job and poll the next port in the polling sequence.
	Source Routing	Sets the source routing option.
	Speed	Sets the default ring speed of the Token Ring interface.
	LAA	Sets the six byte Locally Administered Address.

Table 1.23 Page 2 of 2

Refer to Table 1.24 on page 1-81 for step-by-step instructions.

Table 1.24 Token Ring Menu Functions

Menu Item and Function	Keystrokes	Display
LPR Enable Enable or disable the Token Ring LPR protocol. The available values are: On* Off	1. Press Menu Up or Menu Down until you see:	Menus Token Ring Menu
	2. Press Item Up or Item Down until you see:	Token Ring Menu LPR Enable
	3. Press Value Up or Value Down until you see:	LPR Enable = New Value
	4. Press Enter . You will see:	Token Ring Menu LPR Enable
	5. Press Online . You will see:	Ready
LPR Banner Enable or disable the LPR banner sheet. The available values are: On* Off	1. Press Menu Up or Menu Down until you see:	Menus Token Ring Menu
	2. Press Item Up or Item Down until you see:	Token Ring Menu LPR Banner
	3. Press Value Up or Value Down until you see:	LPR Banner = New Value
	4. Press Enter . You will see:	Token Ring Menu LPR Banner
	5. Press Online . You will see:	Ready

Table 1.24 Page 1 of 14

Table 1.24 Token Ring Menu Functions (continued)

Menu Item and Function	Keystrokes	Display
LPR PDL Set the default emulation (page description language) for the Token Ring LPR protocol. The available values are: Auto* PCL PostScript When set to <i>Auto</i> , the printer will sense the PDL for each job and automatically set the PDL accordingly.	1. Press Menu Up or Menu Down until you see:	Menus Token Ring Menu
	2. Press Item Up or Item Down until you see:	Token Ring Menu LPR PDL
	3. Press Value Up or Value Down until you see:	LPR PDL = New Value
	4. Press Enter . You will see:	Token Ring Menu LPR PDL
	5. Press Online . You will see:	Ready
LPR Binary PS Enable or disable the LPR binary mode of PostScript. The available values are: On Off*	1. Press Menu Up or Menu Down until you see:	Menus Token Ring Menu
	2. Press Item Up or Item Down until you see:	Token Ring Menu LPR Binary PS
	3. Press Value Up or Value Down until you see:	LPR Binary PS = New Value
	4. Press Enter . You will see:	Token Ring Menu LPR Binary PS
	5. Press Online . You will see:	Ready

Table 1.24 Page 2 of 14

Table 1.24 Token Ring Menu Functions (continued)

Menu Item and Function	Keystrokes	Display
DLC/LLC Enable Enable or disable the DLC/LLC protocol. The available values are: On* Off	1. Press Menu Up or Menu Down until you see:	Menus Token Ring Menu
	2. Press Item Up or Item Down until you see:	Token Ring Menu DLC/LLC Enable
	3. Press Value Up or Value Down until you see:	DLC/LLC Enable = New Value
	4. Press Enter . You will see:	Token Ring Menu DLC/LLC Enable
	5. Press Online . You will see:	Ready
DLC/LLC PDL Set the default emulation (page description language) for the DLC/LLC protocol. The available values are: Auto* PCL PostScript	1. Press Menu Up or Menu Down until you see:	Menus Token Ring Menu
	2. Press Item Up or Item Down until you see:	Token Ring Menu DLC/LLC PDL
	3. Press Value Up or Value Down until you see:	DLC/LLC PDL = New Value
	4. Press Enter . You will see:	Token Ring Menu DLC/LLC PDL
	5. Press Online . You will see:	Ready

Table 1.24 Page 3 of 14

Table 1.24 Token Ring Menu Functions (continued)

Menu Item and Function	Keystrokes	Display
DLC/LLC Bin PS Enable or disable the DLC/LLC binary mode of PostScript. The available values are: On Off*	1. Press Menu Up or Menu Down until you see:	Menus Token Ring Menu
	2. Press Item Up or Item Down until you see:	Token Ring Menu DLC/LLC Bin PS
	3. Press Value Up or Value Down until you see:	DLC/LLC Bin PS = New Value
	4. Press Enter . You will see:	Token Ring Menu DLC/LLC Bin PS
	5. Press Online . You will see:	Ready
NetBEUI Enable Enable or disable the NetBEUI protocol. The available values are: On* Off	1. Press Menu Up or Menu Down until you see:	Menus Token Ring Menu
	2. Press Item Up or Item Down until you see:	Token Ring Menu NetBEUI Enable
	3. Press Value Up or Value Down until you see:	NetBEUI Enable = New Value
	4. Press Enter . You will see:	Token Ring Menu NetBEUI Enable
	5. Press Online . You will see:	Ready

Table 1.24 Page 4 of 14

Table 1.24 Token Ring Menu Functions (continued)

Menu Item and Function	Keystrokes	Display
NetBEUI PDL Set the default emulation (page description language) for the NetBEUI protocol. The available values are: Auto* PCL PostScript When set to <i>Auto</i> , the printer will sense the PDL for each job and automatically set the PDL accordingly.	1. Press Menu Up or Menu Down until you see:	Menus Token Ring Menu
	2. Press Item Up or Item Down until you see:	Token Ring Menu NetBEUI PDL
	3. Press Value Up or Value Down until you see:	NetBEUI PDL = New Value
	4. Press Enter . You will see:	Token Ring Menu NetBEUI PDL
	5. Press Online . You will see:	Ready
NetBEUI Bin PS Enable or disable the NetBEUI binary mode of PostScript. The available values are: On Off*	1. Press Menu Up or Menu Down until you see:	Menus Token Ring Menu
	2. Press Item Up or Item Down until you see:	Token Ring Menu NetBEUI Bin PS
	3. Press Value Up or Value Down until you see:	NetBEUI Bin PS = New Value
	4. Press Enter . You will see:	Token Ring Menu NetBEUI Bin PS
	5. Press Online . You will see:	Ready

Table 1.24 Page 5 of 14

Table 1.24 Token Ring Menu Functions (continued)

Menu Item and Function	Keystrokes	Display
AppSocket Enabl Enable or disable the Token Ring AppSocket protocol. The AppSocket in the printer supports Ports 2000, 9100, and 2105. The available values are: On* Off	1. Press Menu Up or Menu Down until you see:	Menus Token Ring Menu
	2. Press Item Up or Item Down until you see:	Token Ring Menu AppSocket Enabl
	3. Press Value Up or Value Down until you see:	AppSocket Enabl= New Value
	4. Press Enter . You will see:	Token Ring Menu AppSocket Enabl
	5. Press Online . You will see:	Ready
AppSocket PDL Set the default emulation (page description language) for the Token Ring AppSocket protocol. The available values are: Auto* PCL PostScript	1. Press Menu Up or Menu Down until you see:	Menus Token Ring Menu
	2. Press Item Up or Item Down until you see:	Token Ring Menu AppSocket PDL
	3. Press Value Up or Value Down until you see:	AppSocket PDL = New Value
	4. Press Enter . You will see:	Token Ring Menu AppSocket PDL
	5. Press Online . You will see:	Ready

Table 1.24 Page 6 of 14

Table 1.24 Token Ring Menu Functions (continued)

Menu Item and Function	Keystrokes	Display
AppSocket Bin PS Enable or disable the AppSocket binary mode of PostScript. The available values are: On Off*	1. Press Menu Up or Menu Down until you see:	Menus Token Ring Menu
	2. Press Item Up or Item Down until you see:	Token Ring Menu AppSocket Bin PS
	3. Press Value Up or Value Down until you see:	AppSocket Bin PS= New Value
	4. Press Enter . You will see:	Token Ring Menu AppSocket Bin PS
	5. Press Online . You will see:	Ready
TTalk Enable Enable or disable the Token Ring TokenTalk protocol. The available values are: On* Off	1. Press Menu Up or Menu Down until you see:	Menus Token Ring Menu
	2. Press Item Up or Item Down until you see:	Token Ring Menu TokenTalk Enable
	3. Press Value Up or Value Down until you see:	TokenTalk Enable= New Value
	4. Press Enter . You will see:	Token Ring Menu TokenTalk Enable
	5. Press Online . You will see:	Ready

Table 1.24 Page 7 of 14

Table 1.24 Token Ring Menu Functions (continued)

Menu Item and Function	Keystrokes	Display
HTTP Enable Enable or disable the Token Ring HTTP Server protocol. The available values are: On* Off	1. Press Menu Up or Menu Down until you see:	Menus Token Ring Menu
	2. Press Item Up or Item Down until you see:	Token Ring Menu HTTP Enable
	3. Press Value Up or Value Down until you see:	HTTP Enable = New Value
	4. Press Enter . You will see:	Token Ring Menu HTTP Enable
	5. Press Online . You will see:	Ready
IP Address Res. When set to <i>Static</i> , values can be set for IP Address, Sub Net Mask and Default Gateway. The available values are: Static BOOTP/RARP DHCP*	1. Press Menu Up or Menu Down until you see:	Menus Token Ring Menu
	2. Press Item Up or Item Down until you see:	Token Ring Menu IP Address Res.
	3. Press Value Up or Value Down until you see:	IP Address Res.= New Value
	4. Press Enter . You will see:	Token Ring Menu IP Address Res.
	5. Press Online . You will see:	Ready

Table 1.24 Page 8 of 14

Table 1.24 Token Ring Menu Functions (continued)

Menu Item and Function	Keystrokes	Display
<p>IP Address</p> <p> <i>This item appears only if IP Address Res is set to Static.</i></p> <p>Set the four byte IP address.</p> <p>The available values are: xxx.xxx.xxx.xxx (where xxx = 000 to 255)</p> <p>For this item (after Step 3), Item Up moves the cursor to the right through the displayed IP address and Item Down moves the cursor to the left. This allows you to change characters within the string rather than having to reenter the entire string.</p> <p>With the cursor displayed under a character, Value Up increments the value of that character and Value Down decrements the value.</p>	1. Press Menu Up or Menu Down until you see:	Menus Token Ring Menu
	2. Press Item Up or Item Down until you see:	Token Ring Menu IP Address
	3. Press Value Up or Value Down . You will see:	IP Address = xxx.xxx.xxx.xxx
	4. Press Value Up or Value Down to change the value of the character above the cursor. The value is incremented or decremented by 1 each time the key is pressed. Holding down Value Up or Value Down causes continuous scrolling through the values.	IP Address = xxx.xxx.xxx.xxx
	5. To change other characters in the IP address, press Item Up or Item Down to scroll right or left respectively through the character string, then press Value Up or Value Down to change the value of the character above the cursor (as in Step 4).	IP Address = xxx.xxx.xxx.xxx
	6. When you have completed setting the IP address, press Enter . You will see:	Token Ring Menu IP Address
	7. Press Online . You will see:	Ready
	8. Restart printer or power off/on.	

Table 1.24 Page 9 of 14

Table 1.24 Token Ring Menu Functions (continued)

Menu Item and Function	Keystrokes	Display
<p>Sub Net Mask</p> <p> <i>This item appears only if IP Address Res is set to Static.</i></p> <p>Set the four byte Subnet Mask address.</p> <p>The available values are:</p> <p>xxx.xxx.xxx.xxx (where xxx = 000 to 255)</p> <p>For this item (after Step 3), Item Up moves the cursor to the right through the displayed Subnet Mask address and Item Down moves the cursor to the left. This allows you to change characters within the string rather than having to reenter the entire string.</p> <p>With the cursor displayed under a character, Value Up increments the value of that character and Value Down decrements the value.</p>	1. Press Menu Up or Menu Down until you see:	Menus Token Ring Menu
	2. Press Item Up or Item Down until you see:	Token Ring Menu Sub Net Mask
	3. Press Value Up or Value Down . You will see:	Sub Net Mask = xxx.xxx.xxx.xxx
	4. Press Value Up or Value Down to change the value of the character above the cursor. The value is incremented or decremented by 1 each time the key is pressed. Holding down Value Up or Value Down causes continuous scrolling through the values.	Sub Net Mask = xxx.xxx.xxx.xxx
	5. To change other characters in the Subnet Mask address, press Item Up or Item Down to scroll right or left respectively through the character string, then press Value Up or Value Down to change the value of the character above the cursor (as in Step 4).	Sub Net Mask = xxx.xxx.xxx.xxx
	6. When you have completed setting the Subnet Mask address, press Enter . You will see:	Token Ring Menu Sub Net Mask
	7. Press Online . You will see:	Ready
	8. Restart printer or power off/on.	

Table 1.24 Page 10 of 14

Table 1.24 Token Ring Menu Functions (continued)

Menu Item and Function	Keystrokes	Display
<p>Default Gateway</p> <p> <i>This item appears only if IP Address Res is set to Static.</i></p> <p>Set the four byte Default Gateway address.</p> <p>The available values are:</p> <p>xxx.xxx.xxx.xxx (where xxx = 000 to 255)</p> <p>For this item (after Step 3), Item Up moves the cursor to the right through the displayed Default Gateway address and Item Down moves the cursor to the left. This allows you to change characters within the string rather than having to reenter the entire string.</p> <p>With the cursor displayed under a character, Value Up increments the value of that character and Value Down decrements the value.</p>	1. Press Menu Up or Menu Down until you see:	Menus Token Ring Menu
	2. Press Item Up or Item Down until you see:	Token Ring Menu Default Gateway
	3. Press Value Up or Value Down . You will see:	Default Gateway= xxx.xxx.xxx.xxx
	4. Press Value Up or Value Down to change the value of the character above the cursor. The value is incremented or decremented by 1 each time the key is pressed. Holding down Value Up or Value Down causes continuous scrolling through the values.	Default Gateway= xxx.xxx.xxx.xxx
	5. To change other characters in the Default Gateway address, press Item Up or Item Down to scroll right or left respectively through the character string, then press Value Up or Value Down to change the value of the character above the cursor (as in Step 4).	Default Gateway= xxx.xxx.xxx.xxx
	6. When you have completed setting the Default Gateway address, press Enter . You will see:	Token Ring Menu Default Gateway
	7. Press Online . You will see:	Ready
	8. Restart printer or power off/on.	

Table 1.24 Page 11 of 14

Table 1.24 Token Ring Menu Functions (continued)

Menu Item and Function	Keystrokes	Display
<p>Port Timeout</p> <p>Set the time for determining when to end an incomplete print job and poll the next port in the polling sequence.</p> <p>The available values are:</p> <p>5 - 300 seconds (60*)</p> <p>This item also causes an implicit job end such as Control D in PostScript or <ESC> E in PCL, and invokes the emulation functions associated with this action (e.g., formfeed, reset, etc.).</p> <p>The time changes incrementally by 1 second each time either Value Up or Value Down is pressed. Holding down Value Up or Value Down causes continuous scrolling through the values.</p>	1. Press Menu Up or Menu Down until you see:	Menus Token Ring Menu
	2. Press Item Up or Item Down until you see:	Token Ring Menu Port Timeout
	3. Press Value Up or Value Down until you see:	Port Timeout = New Value
	4. Press Enter . You will see:	Token Ring Menu Port Timeout
	5. Press Online . You will see:	Ready

Table 1.24 Page 12 of 14

Table 1.24 Token Ring Menu Functions (continued)

Menu Item and Function	Keystrokes	Display
Source Routing Select the Source Routing option. The available values are: Off* All Single/All Single/Specific	1. Press Menu Up or Menu Down until you see:	Menus Token Ring Menu
	2. Press Item Up or Item Down until you see:	Token Ring Menu Source Routing
	3. Press Value Up or Value Down until you see:	Source Routing = New Value
	4. Press Enter . You will see:	Token Ring Menu Source Routing
	5. Press Online . You will see:	Ready
Speed Select the Token Ring speed option. The available values (in Mbits) are: 4 16*	1. Press Menu Up or Menu Down until you see:	Menus Token Ring Menu
	2. Press Item Up or Item Down until you see:	Token Ring Menu Speed
	3. Press Value Up or Value Down until you see:	Speed = New Value
	4. Press Enter . You will see:	Token Ring Menu Speed
	5. Press Online . You will see:	Ready

Table 1.24 Page 13 of 14

Table 1.24 Token Ring Menu Functions (continued)

Menu Item and Function	Keystrokes	Display
<p>LAA</p> <p>Set the six byte Locally Administered Address.</p> <p>The valid values are:</p> <p>xxxx xxxx xxxx (where xxxx xxxx xxxx can equal any value within the valid range of 4000 0000 0000 and 7FFF FFFF FFFF)</p> <p>For this item (after Step 3), Item Up moves the cursor to the right through the displayed LAA and Item Down moves the cursor to the left. This allows you to change characters within the string rather than having to reenter the entire string.</p> <p>With the cursor displayed under a character, Value Up increments the value of that character and Value Down decrements the value.</p>	<p>1. Press Menu Up or Menu Down until you see:</p>	<p>Menus Token Ring Menu</p>
	<p>2. Press Item Up or Item Down until you see:</p>	<p>Token Ring Menu LAA</p>
	<p>3. Press Value Up or Value Down. You will see:</p>	<p>LAA = xxxx xxxx xxxx</p>
	<p>4. Press Value Up or Value Down to change the value of the character above the cursor. The value is incremented or decremented by 1 each time the key is pressed. Holding down Value Up or Value Down causes continuous scrolling through the values.</p>	<p>LAA = xxxx xxxx xxxx</p>
	<p>5. To change other characters in the LAA, press Item Up or Item Down to scroll right or left respectively through the character string, then press Value Up or Value Down to change the value of the character above the cursor (as in Step 4).</p>	<p>LAA = xxxx xxxx xxxx</p>
	<p>6. When you have completed setting the LAA, press Enter. You will see:</p>	<p>Token Ring Menu LAA</p>
	<p>7. Press Online. You will see:</p>	<p>Ready</p>

Novell Menu The Novell Menu and its available items are described in Table 1.25. This menu appears only on network capable printers.

Table 1.25 Novell Menu Items

Menu	Description	
Novell Menu	Allows you to modify Novell parameters.	
	Menu Items	Description
	Novell Enable	Enables or disables the Novell protocol. If set to <i>Off</i> , the following menu items do not appear.
	Novell PDL	Sets the default emulation (page description language) for the Novell protocol.
	Novell Binary PS	Enables or disables the Novell binary mode of PostScript.
	Novell Mode	Sets the PServer mode for the Novell protocol.
	Frame Type	Sets the frame type used for the Novell protocol.
	Polling Interval	Sets the rate (in seconds) at which the PServer issues polling requests for assigned queues.
	PServer Name	Sets the name of the PServer in this printer.
	Primary Server	Sets the name of the Primary file server.
	NDS Tree	Sets the NDS Tree character string.
	NDS Context	Set the NDS context string.

Refer to Table 1.26 on page 1-96 for step-by-step instructions.

Table 1.26 Novell Menu Functions

Menu Item and Function	Keystrokes	Display
Novell Enable Enable or disable the Novell protocol. The available values are: On* Off If set to <i>Off</i> , the following menu items do not appear.	1. Press Menu Up or Menu Down until you see:	Menus Novell Menu
	2. Press Item Up or Item Down until you see:	Novell Menu Novell Enable
	3. Press Value Up or Value Down until you see:	Novell Enable = New Value
	4. Press Enter . You will see:	Novell Menu Novell Enable
	5. Press Online . You will see:	Ready
Novell PDL Set the default emulation (page description language) for the Novell protocol. The available values are: Auto* PCL PostScript	1. Press Menu Up or Menu Down until you see:	Menus Novell Menu
	2. Press Item Up or Item Down until you see:	Novell Menu Novell PDL
	3. Press Value Up or Value Down until you see:	Novell PDL = New Value
	4. Press Enter . You will see:	Novell Menu Novell PDL
	5. Press Online . You will see:	Ready

Table 1.26 Page 1 of 7

Table 1.26 Novell Menu Functions (continued)

Menu Item and Function	Keystrokes	Display
Novell Binary PS Enable or disable the Novell binary mode of PostScript. The available values are: On Off*	1. Press Menu Up or Menu Down until you see:	Menus Novell Menu
	2. Press Item Up or Item Down until you see:	Novell Menu Novell Binary PS
	3. Press Value Up or Value Down until you see:	Novell Binary PS= New Value
	4. Press Enter . You will see:	Novell Menu Novell Binary PS
	5. Press Online . You will see:	Ready
Novell Mode Set the PServer mode for the Novell protocol. The available values are: NDS BEM NDS/BEM*	1. Press Menu Up or Menu Down until you see:	Menus Novell Menu
	2. Press Item Up or Item Down until you see:	Novell Menu Novell Mode
	3. Press Value Up or Value Down until you see:	Novell Mode = New Value
	4. Press Enter . You will see:	Novell Menu Novell Mode
	5. Press Online . You will see:	Ready

Table 1.26 Page 2 of 7

Table 1.26 Novell Menu Functions (continued)

Menu Item and Function	Keystrokes	Display
<p>Frame Type</p> <p>Sets the frame type used for the Novell protocol.</p> <p>The available values are, for Ethernet:</p> <p>Auto* 802.2 802.3 SNAP Ethernet II</p> <p>For Token Ring:</p> <p>Auto* TR_802.5 TR_SNAP</p>	1. Press Menu Up or Menu Down until you see:	Menus Novell Menu
	2. Press Item Up or Item Down until you see:	Novell Menu Frame Type
	3. Press Value Up or Value Down until you see:	Frame Type = New Value
	4. Press Enter . You will see:	Novell Menu Frame Type
	5. Press Online . You will see:	Ready
<p>Polling Interval</p> <p>Set the rate (in seconds) at which the PServer issues polling requests for assigned queues.</p> <p>The available values are:</p> <p>1 - 29 (2*)</p> <p>The Polling Interval changes incrementally by 1 each time either Value Up or Value Down is pressed. Holding down Value Up or Value Down causes continuous scrolling through the values.</p>	1. Press Menu Up or Menu Down until you see:	Menus Novell Menu
	2. Press Item Up or Item Down until you see:	Novell Menu Polling Interval
	3. Press Value Up or Value Down until you see:	Polling Interval= New Value
	4. Press Enter . You will see:	Novell Menu Polling Interval
	5. Press Online . You will see:	Ready

Table 1.26 Page 3 of 7

Table 1.26 Novell Menu Functions (continued)

Menu Item and Function	Keystrokes	Display
<p>PServer Name</p> <p>Set the name of the PServer in this printer (a name of 1 to 47 characters in length).</p> <p>The available characters are: A - Z, 0 - 9, hyphen (-), underscore (_)</p> <p>The default is: XXR_<macaddress>*</p> <p>For this item (after Step 3), Item Up moves the cursor to the right through the displayed PServer name and Item Down moves the cursor to the left. This allows you to change characters within the string rather than having to reenter the entire string.</p> <p>With the cursor displayed under a character, Value Up increments the value of that character and Value Down decrements the value.</p>	1. Press Menu Up or Menu Down until you see:	Menus Novell Menu
	2. Press Item Up or Item Down until you see:	Novell Menu PServer Name
	3. Press Value Up or Value Down . You will see:	PServer Name = xxx...xxx
	4. Press Value Up or Value Down to change the value of the character above the cursor. The value is incremented or decremented by 1 each time the key is pressed. Holding down Value Up or Value Down causes continuous scrolling through the values.	PServer Name = xxx...xxx
	5. To change other characters in the PServer name, press Item Up or Item Down to scroll right or left respectively through the character string, then press Value Up or Value Down to change the value of the character above the cursor (as in Step 4).	PServer Name = xxx...xxx
	6. When you have completed setting the PServer Name, press Enter . You will see:	Novell Menu PServer Name
	7. Press Online . You will see:	Ready

Table 1.26 Page 4 of 7

Table 1.26 Novell Menu Functions (continued)

Menu Item and Function	Keystrokes	Display
<p>Primary Server</p> <p>Set the name of the Primary file server (a name of 1 to 47 characters in length).</p> <p>The available characters are: A - Z, 0 - 9, hyphen (-) and underscore (_)</p> <p>The default is: Null*</p> <p>For this item (after Step 3), Item Up moves the cursor to the right through the displayed Primary Server name and Item Down moves the cursor to the left. This allows you to change characters within the string rather than having to reenter the entire string.</p> <p>With the cursor displayed under a character, Value Up increments the value of that character and Value Down decrements the value.</p>	1. Press Menu Up or Menu Down until you see:	Menus Novell Menu
	2. Press Item Up or Item Down until you see:	Novell Menu Primary Server
	3. Press Value Up or Value Down . You will see:	Primary Server = xxx...xxx
	4. Press Value Up or Value Down to change the value of the character above the cursor. The value is incremented or decremented by 1 each time the key is pressed. Holding down Value Up or Value Down causes continuous scrolling through the values.	Primary Server = xxx...xxx
	5. To change other characters in the Primary Server name, press Item Up or Item Down to scroll right or left respectively through the character string, then press Value Up or Value Down to change the value of the character above the cursor (as in Step 4).	Primary Server = xxx...xxx
	6. When you have completed setting the Primary Server name, press Enter . You will see:	Novell Menu Primary Server
	7. Press Online . You will see:	Ready

Table 1.26 Page 5 of 7

Table 1.26 Novell Menu Functions (continued)

Menu Item and Function	Keystrokes	Display
<p>NDS Tree</p> <p>Set the NDS Tree character string (from 1 to 64 characters in length).</p> <p>The available characters are:</p> <p>A - Z, 0 - 9, hyphen (-) and underscore (_)</p> <p>The default is:</p> <p>Null*</p> <p>For this item (after Step 3), Item Up moves the cursor to the right through the displayed NDS Tree character string and Item Down moves the cursor to the left. This allows you to change characters within the string rather than having to reenter the entire string.</p> <p>With the cursor displayed under a character, Value Up increments the value of that character and Value Down decrements the value.</p>	1. Press Menu Up or Menu Down until you see:	Menus Novell Menu
	2. Press Item Up or Item Down until you see:	Novell Menu NDS Tree
	3. Press Value Up or Value Down . You will see:	NDS Tree = xxx...xxx
	4. Press Value Up or Value Down to change the value of the character above the cursor. The value is incremented or decremented by 1 each time the key is pressed. Holding down Value Up or Value Down causes continuous scrolling through the values.	NDS Tree = xxx...xxx
	5. To change other characters in the NDS Tree character string, press Item Up or Item Down to scroll right or left respectively through the character string, then press Value Up or Value Down to change the value of the character above the cursor (as in Step 4).	NDS Tree = xxx...xxx
	6. When you have completed setting the NDS Tree, press Enter . You will see:	Novell Menu NDS Tree
	7. Press Online . You will see:	Ready

Table 1.26 Page 6 of 7

Table 1.26 Novell Menu Functions (continued)

Menu Item and Function	Keystrokes	Display
<p>NDS Context</p> <p>Set the NDS context string (from 1 to 255 characters in length).</p> <p>The available characters are:</p> <p>A - Z, 0 - 9, hyphen (-), period (.), underscore (_), equal (=)</p> <p>The default is:</p> <p>Null*</p> <p>For this item (after Step 3), Item Up moves the cursor to the right through the displayed NDS Context string and Item Down moves the cursor to the left. This allows you to change characters within the string rather than having to reenter the entire string.</p> <p>With the cursor displayed under a character, Value Up increments the value of that character and Value Down decrements the value.</p>	1. Press Menu Up or Menu Down until you see:	<p>Menus</p> <p>Novell Menu</p>
	2. Press Item Up or Item Down until you see:	<p>Novell Menu</p> <p>NDS Context</p>
	3. Press Value Up or Value Down . You will see:	<p>NDS Context =</p> <p>xxx...xxx</p>
	4. Press Value Up or Value Down to change the value of the character above the cursor. The value is incremented or decremented by 1 each time the key is pressed. Holding down Value Up or Value Down causes continuous scrolling through the values.	<p>NDS Context =</p> <p>xxx...xxx</p>
	5. To change other characters in the NDS Context string, press Item Up or Item Down to scroll right or left respectively through the character string, then press Value Up or Value Down to change the value of the character above the cursor (as in Step 4).	<p>NDS Context =</p> <p>xxx...xxx</p>
	6. When you have completed setting the NDS Context, press Enter . You will see:	<p>Novell Menu</p> <p>NDS Context</p>
	7. Press Online . You will see:	<p>Ready</p>

Table 1.26 Page 7 of 7

Print Menu

The Print Menu and its available items are described in Table 1.27.

Table 1.27 Print Menu Items

Menu	Description	
Print Menu	Allows you to generate printer reports.	
	Menu Items	Description
	Config Sheet	Prints a Configuration Sheet showing the printer's current information and menu settings.
	PCL Demo	Prints a sample page demonstrating the printer's capabilities.
	PCL Font List	Prints a list of PCL fonts currently loaded.
	PS Font List	Prints a complete list of all PostScript language typefaces installed.
	Menu Map	Prints a page showing the structure of the Control Panel Menu Tree.
	Test Print	Prints a "test pattern" for analysis of print quality over the entire page (intended for use by the service technician).
	Disk Directory	Prints a copy of the disk directory (and appears only if the optional hard drive is installed).
	Fault History	Prints a copy of the Fault History Log.
	Display Faults	Displays the last 100 faults on the Control Panel.
	Hex Mode	Enables or disables hex dump mode, which prints the data stream as hex codes instead of interpreting it as print data.
Restart Printer	Reboots the printer as if the power was cycled but bypasses the power on diagnostics.	

Refer to Table 1.28 on page 1-104 for step-by-step instructions.

Table 1.28 Print Menu Functions

Menu Item and Function	Keystrokes	Display
<p>Config Sheet</p> <p>Print a Configuration Sheet showing the printer's current information and menu settings.</p> <p>The Configuration Sheet is formatted for either Letter or A4 paper size, regardless of the default paper size or the actual paper size loaded.</p>	1. Press Menu Up or Menu Down until you see:	Menus Print Menu
	2. Press Item Up or Item Down until you see:	Print Menu Config Sheet
	3. Press Enter . You will see:	Processing... Config Sheet
	4. When completed, you will see:	Ready
<p>PCL Demo</p> <p>Print a PCL demonstration page that shows the printer features.</p> <p>The PCL Demo page is formatted for either Letter or A4 paper size, regardless of the default paper size or the actual paper size loaded.</p>	1. Press Menu Up or Menu Down until you see:	Menus Print Menu
	2. Press Item Up or Item Down until you see:	Print Menu PCL Demo
	3. Press Enter . You will see:	Processing... DEMO
	4. When completed, you will see:	Ready

Table 1.28 Page 1 of 5

Table 1.28 Print Menu Functions (continued)

Menu Item and Function	Keystrokes	Display
PCL Font List Print a list of PCL fonts currently loaded. The PCL Font List is formatted for either Letter or A4 paper size, regardless of the default paper size or the actual paper size loaded. There are no multiple copies. The Print Menu setting for Print Quantity is ignored. Source tray is determined by the Select Tray item.	1. Press Menu Up or Menu Down until you see:	Menus Print Menu
	2. Press Item Up or Item Down until you see:	Print Menu PCL Font List
	3. Press Enter . You will see:	Processing... PCL Font List
	4. When completed, you will see:	Ready
PS Font List Print the list of the fonts available in PostScript, including resident fonts and fonts stored on the hard disk. The PS Font List is formatted for either Letter or A4 paper size, regardless of the default paper size or the actual paper size loaded	1. Press Menu Up or Menu Down until you see:	Menus Print Menu
	2. Press Item Up or Item Down until you see:	Print Menu PS Font List
	3. Press Enter . You will see:	Processing... PostScript
	4. When completed, you will see:	Ready

Table 1.28 Page 2 of 5

Table 1.28 Print Menu Functions (continued)

Menu Item and Function	Keystrokes	Display
<p>Menu Map</p> <p>Print the menu map/Control Panel menu tree.</p> <p>Menu Maps are formatted for either Letter or A4 paper size, regardless of the default paper size or the actual paper size loaded. There are no multiple copies. The Print Menu setting for Print Quantity is ignored. Source tray is determined by the Select Tray item.</p>	1. Press Menu Up or Menu Down until you see:	Menus Print Menu
	2. Press Item Up or Item Down until you see:	Print Menu Menu Map
	3. Press Enter . You will see:	Processing... Menu Map
	4. When completed, you will see:	Ready
<p>Test Print</p> <p>Print a two-page test pattern which you (or service personnel) can use to analyze print quality.</p> <p>Test patterns are printed using PCL, System menu Print Quantity, default source and default type, at 600x600 dpi.</p>	1. Press Menu Up or Menu Down until you see:	Menus Print Menu
	2. Press Item Up or Item Down until you see:	Print Menu Test Print
	3. Press Enter . You will see:	Processing... Test Print
	4. When completed, you will see:	Ready
<p>Disk Directory</p> <p>Print a list of files, fonts and macros downloaded to the hard disk.</p>	1. Press Menu Up or Menu Down until you see:	Menus Print Menu
	2. Press Item Up or Item Down until you see:	Print Menu Disk Directory
	3. Press Enter . You will see:	Processing... Disk Directory
	4. When completed, you will see:	Ready

Table 1.28 Page 3 of 5

Table 1.28 Print Menu Functions (continued)

Menu Item and Function	Keystrokes	Display
Fault History Print a log of the printer's last 100 faults.	1. Press Menu Up or Menu Down until you see:	Menus Print Menu
	2. Press Item Up or Item Down until you see:	Print Menu Fault History
	3. Press Enter . You will see:	Processing... Fault History
	4. When completed, you will see:	Ready
Display Faults Display the last 100 faults on the Control Panel, from most recent (the default) to oldest.  <i>In the Control Panel display for Step 3 at right, N is the entry # 1 - 100, and M is the page count when the fault occurred.</i>	1. Press Menu Up or Menu Down until you see:	Menus Print Menu
	2. Press Item Up or Item Down until you see:	Print Menu Display Faults
	3. Press Value Up or Value Down . You will see:	Log Entry #N Fault Code #M
	4. Press Enter . You will see:	Print Menu Display Faults
	5. Press Online . You will see:	Ready

Table 1.28 Page 4 of 5

Table 1.28 Print Menu Functions (continued)

Menu Item and Function	Keystrokes	Display
Hex Mode Set to print output as hexadecimal codes instead of normal print data. The available values are: On Off*	1. Press Menu Up or Menu Down until you see:	Menus Print Menu
	2. Press Item Up or Item Down until you see:	Print Menu Hex Mode
	3. Press Value Up or Value Down until you see:	Hex Mode = New Value
	4. Press Enter . You will see:	Print Menu Hex Mode
	5. Press Online . You will see:	Ready
Restart Printer Reboot the printer without powering it off and powering it on again. The available values are: Yes No*  You must select Yes and press Enter for this function to take effect.	1. Press Menu Up or Menu Down until you see:	Menus Print Menu
	2. Press Item Up or Item Down until you see:	Print Menu Restart Printer
	3. Press Value Up or Value Down until you see:	Restart Printer= New Value
	4. Press Enter . When the action is complete you will see:	Ready

Table 1.28 Page 5 of 5

Reset Menu

The Reset Menu (which only appears in the Main Menu if the printer is powered on while simultaneously holding down the **Online** and **Enter** keys) and its available items are described in Table 1.29.

Table 1.29 Reset Menu Items

Menu	Description	
Reset Menu	Allows you to access printer reset functions (and appears only when the printer is powered on while holding down the Online and Enter keys).	
	Menu Items	Description
	Factory Defaults	Resets menus (except network) to factory defaults.
	Network Defaults	Resets parameters in the Ethernet, Token Ring, and Novell Menus to factory defaults.
	Demo Mode	Places the printer in demo mode.
	Delete All Jobs	Deletes all secure jobs from the hard disk (and appears only if the optional hard drive is installed).
	Disk Initialize	Initializes the hard disk (and appears only if the optional hard drive is installed).
	Disk Format	Formats the hard disk (and appears only if the optional hard drive is installed)
Flash Format	Formats flash memory (and appears only if flash memory is installed).	

Refer to Table 1.30 on page 1-110 for step-by-step instructions.

Table 1.30 Reset Menu Functions

Menu Item and Function	Keystrokes	Display
Factory Defaults Reset the printer operating parameters to factory default settings. The available values are: Yes No* All NVM values are set to factory defaults, with the exception of "Language" and "Defaults" in the System Menu, which are not affected. No NVM values associated with the Ethernet or Token Ring interfaces are reset. Ethernet and Token Ring values may be reset to factory defaults via the "Network Defaults" item.	1. Press Menu Up or Menu Down until you see:	Menus Reset Menu
	2. Press Item Up or Item Down until you see:	Reset Menu Factory Defaults
	3. Press Value Up or Value Down until you see:	Factory Defaults= Yes
	4. Press Enter . You will see:	Factory Defaults= Please Wait
	5. When the action is complete, you will see:	Ready
Network Defaults Reset all NVM parameters associated with the Ethernet and Token Ring interfaces to factory defaults. The available values are: Yes No*	1. Press Menu Up or Menu Down until you see:	Menus Reset Menu
	2. Press Item Up or Item Down until you see:	Reset Menu Network Defaults
	3. Press Value Up or Value Down until you see:	Network Defaults Yes
	4. Press Enter . You will see:	Network Defaults Please Wait
	5. When the action is complete, you will see:	Ready

Table 1.30 Page 1 of 4

Table 1.30 Reset Menu Functions (continued)

Menu Item and Function	Keystrokes	Display
<p>Demo Mode</p> <p>Place the printer in the Demo Mode. The available values are:</p> <p>Yes No*</p> <p>With the printer in Demo Mode, different factory-installed demo pages can be printed by using the eight Control Panel keys to select the type of demo page and the number of copies.</p> <p>Once Demo Mode is selected, the printer reenters this state automatically every time the power is cycled.</p> <p>Demo Mode can be exited by powering ON the printer while simultaneously holding down the Online and Enter keys.</p>	1. Press Menu Up or Menu Down until you see:	Menus Reset Menu
	2. Press Item Up or Item Down until you see:	Reset Menu Demo Mode
	3. Press Value Up or Value Down until you see:	Demo Mode = Yes
	4. Press Enter . You will see:	Reset Menu Demo Mode
	5. Press Online . You will see:	Ready

Table 1.30 Page 2 of 4

Table 1.30 Reset Menu Functions (continued)

Menu Item and Function	Keystrokes	Display
Delete All Jobs Delete all Secure jobs from the hard disk. The available values are: Yes No*	1. Press Menu Up or Menu Down until you see:	Menus Reset Menu
	2. Press Item Up or Item Down until you see:	Reset Menu Delete All Jobs
	3. Press Value Up or Value Down until you see:	Delete All Jobs= Yes
	4. Press Enter . You will see:	Reset Menu Delete All Jobs
	5. Press Online . You will see:	Ready
Disk Initialize Initialize the Hard Disk Drive. The available values are: Yes No* This function is ignored if the disk is locked (write protected) via a PjL or SNMP command.	1. Press Menu Up or Menu Down until you see:	Menus Reset Menu
	2. Press Item Up or Item Down until you see:	Reset Menu Disk Initialize
	3. Press Value Up or Value Down until you see:	Disk Initialize= Yes
	4. Press Enter . You will see:	Reset Menu Disk Initialize
	5. Press Online . You will see:	Ready

Table 1.30 Page 3 of 4

Table 1.30 Reset Menu Functions (continued)

Menu Item and Function	Keystrokes	Display
Disk Format Format the Hard Disk Drive. The available values are: Yes No* This function is ignored if the disk is locked (write protected) via a PjL or SNMP command.	1. Press Menu Up or Menu Down until you see:	Menus Reset Menu
	2. Press Item Up or Item Down until you see:	Reset Menu Disk Format
	3. Press Value Up or Value Down until you see:	Disk Format = Yes
	4. Press Enter . You will see:	Disk Format Please Wait ...
	5. When the formatting is complete, you will see:	Ready
Flash Format Format flash memory. The available values are: Yes No*	1. Press Menu Up or Menu Down until you see:	Menus Reset Menu
	2. Press Item Up or Item Down until you see:	Reset Menu Flash Format
	3. Press Value Up or Value Down until you see:	Flash Format = Yes
	4. Press Enter . You will see:	Flash Format Please Wait ...
	5. When the formatting is complete, you will see:	Ready

Table 1.30 Page 4 of 4

Configuring Automatic Tray Switching

Automatic tray switching, available for both PCL and PostScript jobs, enables you to group two or more input trays together into one logical tray, and in a specific order in which the trays will be searched to satisfy an input request. Tray switching is useful for:

- Increasing paper capacity.

When the current paper tray runs out of paper, the printer automatically switches to the next tray in the sequence, provided the paper size and type in the next tray is the same size and type as that in the current tray.

- Searching for the correct paper size and type.

If the paper size and type specified in your software application do not match the paper loaded in the current paper tray, the printer automatically searches the next tray in the sequence for a paper size and type that match.

- Loading paper in one tray while printing from another tray (filling an empty tray while printing).

Tray switching is made possible via the Tray Sequence item in the Control Panel's Tray Menu. It enables grouping of Tray 1 in the printer, the multi bypass feeder, and Trays 2 and 3 in the optional 550 sheet feeders (if installed) into a variety of sequence combinations. Tray switching can also be turned off.

Following is a description of the settings and rules for using the Tray Sequence function, along with examples of its use.



The multi bypass feeder is referred to as the MBF in the Control Panel's Tray Sequence settings.

Tray Sequence Settings

The Tray Sequence item in the Control Panel's Tray Menu can be set to any of the settings shown in Table 1.31 below (and to Off).

Table 1.31 Tray switching options in the Tray Menu

Tray Sequence Settings	Description
MBF-1 1-MBF Off	Tray Sequence settings available with base configuration printer.
MBF-2 MBF-1-2 MBF-2-1 1-2 2-1	Additional Tray Sequence settings available when an optional Tray 2 is installed.
MBF-3 MBF-1-2-3 MBF-2-3 MBF-3-1 MBF-3-1-2 1-2-3 2-3 3-1 3-1-2	Additional Tray Sequence settings available when an optional Tray 3 is installed.

Paper Handling Exception Conditions

Table 1.32 on page 1-118 describes the paper selection process based on fully defined or partially defined paper selection parameters. A paper request may include one or more of the following parameters: paper tray, paper size, paper type (e.g., plain, letterhead, etc.).



Specifying a paper source (a specific tray) does not guarantee that paper will be fed from that tray if the type and size can be satisfied from another source. The exception to this is a manual feed request, which always from multi bypass feeder unless overridden by the printer operator.

Table 1.32 Paper handling exception conditions

Paper Type	Paper Size	Paper Source	Size/Type Used
Not specified	Not specified	Not specified	Default size/Default type
Not specified	Not specified	Specified (not manual feed)	Default size; Type configured in specified tray
Not specified	Not specified	Specified (manual feed)	Manual feed request; Default size
Not specified	Specified	Not specified	Specified size/Default type
Not specified	Specified	Specified (not manual feed)	Specified size; Type configured in specified tray
Not specified	Specified	Specified (manual feed)	Manual feed request; Specified size
Specified	Not specified	Not specified	Default size/Specified type
Specified	Not specified	Specified (not manual feed)	Default size/Specified type
Specified	Not specified	Specified (manual feed)	Manual feed request; Default size/Specified type
Specified	Specified	Not specified	Specified size/Specified type
Specified	Specified	Specified (not manual feed)	Specified size/Specified type
Specified	Specified	Specified (manual feed)	Manual feed request; Specified size/Specified type

The fourth column of Table 1.32 defines which paper size and paper type to use based on fully or partially specified paper selection parameters. After the type and size are determined, the next step is to determine which paper tray to use to satisfy the request. If the request can be satisfied by one of the currently configured trays, then the appropriate paper tray is used. (Note that the fourth column of Table 1.32 does not list a paper source to use, even though the paper source may be specified.)

- If the paper source is specified, and the other parameters can be satisfied by that paper source, then the specified source is used.
- If the specified source cannot satisfy the request, but another source can satisfy the paper size and type requested, then that alternate source is used, with no operator intervention required.
- If the specified source cannot satisfy the request, but another source can satisfy the request but is out of paper, then the operator is prompted to load paper in the empty tray that can satisfy the request.

Tray Sequence Rules

When you define a Tray Sequence, the printer searches the input trays for the correct size and type of paper for each job that is submitted.

- If you do not specify an input tray when sending a job to the printer (e.g., no paper source command is sent, or the paper source is set to “Auto” in PCL), the trays included in the Tray Sequence are searched first (in the sequence order), before other trays not in the sequence.
- If you specify an input tray when sending a job to the printer, and that tray is included in the Tray Sequence, the printer will check that tray for the correct size and type of paper.
 - If the tray contains the correct paper, then it is used.
 - If the tray does not contain the correct paper (e.g., it contains other paper or is empty), the other trays in the sequence are searched.
 - If any of these trays contains the correct paper, then it is used.
 - If any of these trays are set to the correct paper size and type but all of the trays in the sequence are empty, then the printer will prompt you to load paper into the specified tray.

- If no trays in the sequence are set to the correct paper size and type, then the remaining trays are searched. If there are no trays that can satisfy the request, then the printer will prompt you to load paper into the specified tray.
- If you include “MBF” in the Tray Sequence setting, a request to feed paper from any other tray in the sequence will be overridden and the printer will attempt to feed paper from the multi bypass feeder first. If the multi bypass feeder is out of paper, then the other trays in the sequence are searched.

Tray Sequence Examples

The examples in Table 1.33 discuss conditions and actions that take place when various Tray Sequence settings are used.

Table 1.33 Tray Sequence examples

Condition	Action(s) Taken
<p>The Tray Sequence is set to 1-2.</p> <ul style="list-style-type: none"> • All trays are set to <i>Letter</i> paper. • There is no paper in Tray 1. • Letter paper is requested with the source set to <i>Auto</i>. 	<p>The printer searches for letter paper in the tray sequence order (1-2). Since Tray 1 is empty, the printer feeds paper from Tray 2 until it becomes empty. When Tray 2 becomes empty, the printer prompts you to load paper. Although Tray 3 also contains letter paper, it is ignored because it is not part of the tray sequence, and the requested paper is configured in at least one of the trays included in the sequence.</p>
<p>The Tray Sequence is set to 1-2-3.</p> <ul style="list-style-type: none"> • A Tray 2 paper source is requested. • All trays meet the size/type requirement. 	<p>The printer feeds paper from Tray 2 because it meets the size and type requested. When Tray 2 becomes empty, the printer feeds from Trays 1 and 3.</p>
<p>The Tray Sequence is set to 2-3.</p> <ul style="list-style-type: none"> • Trays 1 and 2 contain letter paper. • Tray 3 contains legal paper. • Legal paper from Tray 2 is requested. 	<p>The printer feeds from Tray 3 because it is the only tray that meets the size and type requested.</p>

Table 1.33 Page 1 of 2

Table 1.33 Tray Sequence examples (continued)

Condition	Action(s) Taken
The Tray Sequence is set to MBF-1-2 . <ul style="list-style-type: none"> • The MBF is set to <i>Letter</i> paper and contains one sheet of paper. • All other trays contain Letter paper. • Letter paper from Tray 2 is requested. 	The printer feeds the first page of the job from the MBF and subsequent pages from Tray 2.
The Tray Sequence is any setting. <ul style="list-style-type: none"> • All trays contain Letter paper. • Legal paper from Tray 2 is requested. 	The printer prompts you to load legal paper in the MBF since no tray was configured for legal paper.
Table 1.33 Page 2 of 2	

Paper Size/Type Mismatch

Paper size/type mismatch occurs when the requested size is not available in the printer. This can be caused by running out of paper in a tray that is configured for the requested paper, or by requesting a paper that is not configured in the printer. The printer goes off-line under paper mismatch conditions. It automatically returns on-line and continues printing after the paper mismatch condition is resolved.

If a tray is configured for the requested paper, but the tray is out of paper, the display prompts you to load the requested paper (size and type) in the appropriate tray. After the tray is loaded, printing continues.

If the request is for paper that is not configured in the printer, you are prompted to load the requested paper in the first tray of the Tray Sequence setting.

If you do not want to load paper in the first tray of the Tray Sequence setting, two options are available:

- One of the trays may be loaded with the requested size paper and reconfigured via the Tray Menu to match the requested paper type. (See Table 1.10 on page 1-24 for instructions on using the Tray Menu.)
- **Value Up** or **Value Down** may be pressed to scroll through all the trays, displaying the size and type paper in each tray. If one of these alternate papers is acceptable, pressing **Enter** will cause printing to continue on the new paper. Trays are searched in the order specified in the Tray Sequence setting.

Configuring Output Offsetting

The optional Offset Catch Tray supports offsetting output between successive jobs or multiple collated sets of a single job. Offsetting is controlled from the Control Panel or via CentreWare DP.

The following conditions must be met before offsetting occurs between jobs:

- The offset function occurs only between successive jobs that are both destined for the Offset Catch Tray.

For example, a print job may contain a banner sheet in PCL that precedes a PostScript print job. If they are both directed to the Offset Catch Tray, the banner sheet is offset from the PostScript job. If the banner sheet is directed to the standard output bin (no offset capability) and the PostScript job is directed to the Offset Catch Tray, offset does not occur between the banner sheet and the PostScript job. If, however, the next job is directed to the Offset Catch Tray, offset will occur between the PostScript job and the next job.

- The offset function occurs between successive jobs directed to the Offset Catch Tray only if the jobs contain data that results in a sheet being printed and delivered to the bin.

For example, if a PCL job contains <ESCAPE>E sequences at the beginning of a job and there is no printable data separating these commands, the offset does not occur (even though these escape sequences are valid job boundaries).

Examples

In the following example, the offset function is set to On and output is directed to the Offset Catch Tray (2 position offset capability).

Table 1.34 Offsetting Example

Job	Result
JOB #1 (1 copy)	No Offset
JOB #2 (1 copy)	Offset
JOB #3 (1 copy)	No Offset
JOB #4 (3 copies)	
Copy #1	Offset
Copy #2	No Offset
Copy #3	Offset
JOB #5 (1 copy)	No Offset

Configuring Duplex Printing

With the optional duplex unit installed, you can configure the printer to print two-sided (duplex) jobs.

Set the printer driver's **Orientation** option and the System Menu's **Duplex** item to the appropriate settings, as shown in Figure 1.2 on page 1-129.

Figure 1.2 Duplex Orientation and Binding Settings

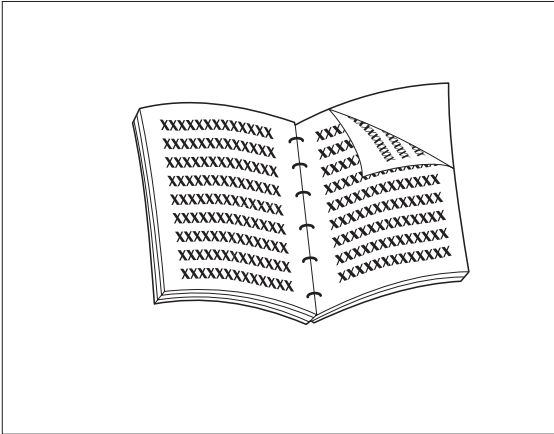

Driver Orientation: *Portrait*
System Menu Duplex Item: *Long Edge*

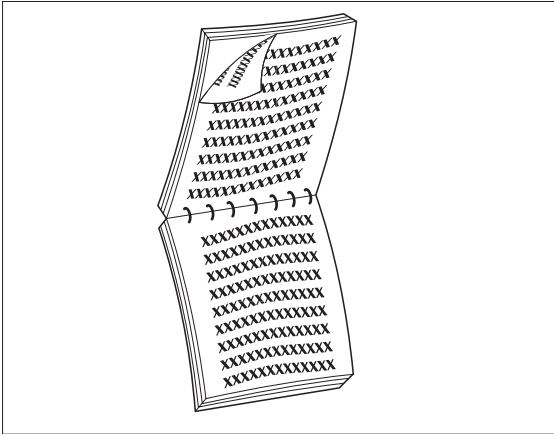

Driver Orientation: *Portrait*
System Menu Duplex Item: *Short Edge*

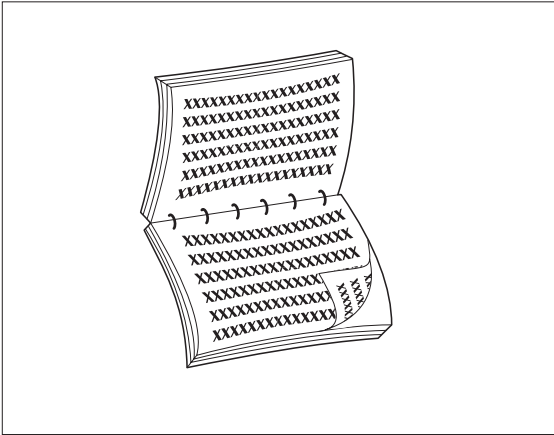

Driver Orientation: *Landscape*
System Menu Duplex Item: *Long Edge*

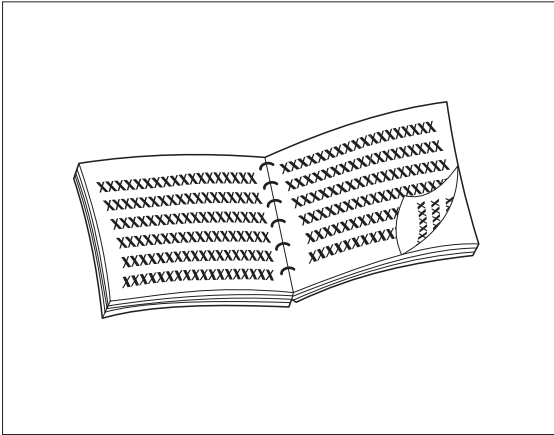

Driver Orientation: *Landscape*
System Menu Duplex Item: *Short Edge*

Configuring Custom Paper Sizes

Custom (nonstandard) paper sizes may be loaded in the multi bypass feeder, any of the 550 sheet trays or the envelope feeder. To use custom paper sizes, there are two basic issues to be addressed:

- You must disable the printer's automatic paper size detection and paper size jam detection.
- Although you may physically load a custom paper size in an input source, because PCL and PostScript format pages to standard sizes, you must properly set margins (or use other application formatting methods) to position the image correctly on the custom paper.

To print on custom size paper, disable the printer's automatic paper size detection and paper size jam detection by setting the Tray Menu's **Tray 1 Mode**, **Tray 2 Mode**, **Tray 3 Mode**, **MBF Size** or **Envelope Size** item (depending on which input source you are using) to *Custom*, then set the **Custom Size** item to the standard size to be used by PCL or PostScript to format the page.



To prevent the printer from incorrectly loading standard paper from another input source when the Custom Size setting is the same value as the auto-detected size in that other input source, you must exclude the tray with the custom size from the Tray Sequence setting and specifically select that tray as the input source.

Specific steps for printing custom paper sizes follow below. Refer to Table 1.35 on page 1-134 for additional usage examples.

1 Choose a standard paper size with a length equal to or longer than the custom paper size that you want to print. In this example, an image that is 7 x 12 inches will be printed on “Folio 8.5 x 13” paper.

2 At the control panel,

3 Press **Menu Up** or **Menu Down** until you see:



```
Menus
Tray Menu
```

4 Press **Item Up** or **Item Down** until you see:



```
Tray Menu
Custom Size
```

5 Press **Value Up** or **Value Down** until you see:

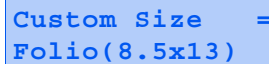

```
Custom Size =
Folio(8.5x13)
```

6 Press **Enter**.

- 7** Press **Menu Up** or **Menu Down** until you see:

```
Menus
Tray Menu
```

- 8** Press **Item Up** or **Item Down** until you see:

```
Tray Menu
Tray N Mode
```

where N is the number of the input tray (1, 2, or 3).

- 9** Press **Value Up** or **Value Down** until you see:

```
Tray N Mode =
Custom
```

- 10** Press **Enter**.

- 11** In the application, set the page setup “paper size” to the same size you set in Step 5.

- 12** Figure out the total width difference between your custom paper size and the standard paper size, then divide that in half. In this example, the standard size width of 8.5 inches minus the custom size width of 7 inches equals 1.5 inches, divided by 2 equals 0.75 inches.
- 13** Add the total from Step 12 to the left and right margin size that you desire for formatting your document. For example, if you desire a half-inch margin, add 0.75 to 0.5 and then set your page margins in the application to 1.25 inches on each side.
- 14** Since the printer prints from the top of the page, the length difference between the standard and custom sizes is added to the bottom margin, and the top margin is unaffected. In this example, the standard size length of 13 inches minus the custom size length of 12 inches equals 1 inch. If you also desire a half-inch margin at the top and bottom of the page, set the top margin in the application to 0.5 inches and the bottom margin to 1.5 inches.
- 15** Load the custom size paper in the specified tray from Step 8 and print.

Table 1.35 Custom Paper Size Examples.

Custom Paper Size	Desired Input Source	Required Steps
8 x 10 in.	Tray 1	<ol style="list-style-type: none"> 1. In the application, format the page for Letter size paper, setting the margins to correctly position the image on 8 x 10 in. paper if overlaid by Letter size paper. 2. Load the 8 x 10 paper in Tray 1. 3. Set the Tray Menu Tray 1 Mode item to <i>Custom</i>. 4. Set the Custom Size item to <i>Letter(8.5x11)</i>. 5. Set the Tray Sequence item to a value that does not include Tray 1 (or set to Off). 6. Request Tray 1 as the paper source and send the print job.
6 x 7 in.	multi bypass feeder	<ol style="list-style-type: none"> 1. In the application, format the page for Letter size paper, setting the margins to correctly position the image on 6 x 7 in. paper if overlaid by Letter size paper. 2. Load the 6 x 7 paper in Tray 1. 3. Set the Tray Menu MBF Size item to <i>Custom</i>. 4. Set the Custom Size item to <i>Letter(8.5x11)</i>. 5. Set the Tray Sequence item to a value that does not include MBF (or set to Off). 6. Request MBF as the paper source and send the print job.

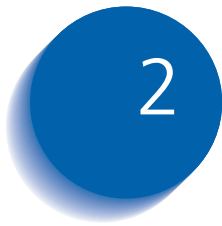

Managing Printer Usage

<i>Using CentreWare DP</i>	<i>2-2</i>
<i>CentreWare Internet Services</i>	<i>2-4</i>

Using CentreWare DP

Xerox CentreWare DP is easy-to-use printer management software for Xerox printers. Through the ease of point-and-click navigation, you can install, connect, and configure the printer on a network, quickly and easily.

CentreWare DP provides network administrators with simplified setup procedures and effortless management of networked printers.

CentreWare DP also provides easily available Help information for questions you may have.

Table 2.1 on page 2-3 lists CentreWare DP key features and benefits. For more specific information about CentreWare DP use and operation, see “The CentreWare DP User Guide.”

Table 2.1 CentreWare DP key features and benefits

Feature	Benefit
Setup Wizard	Provides a step-by-step guide to get your printer quickly up and running on the network.
Advanced Setup	Provides a tool to service multiple file servers and queues.
Instant Status	Allows you to select a printer from the Printer List to see what that printer is doing at any given time.
Remote Configuration and Management	Allows you to do most configuration and monitoring tasks from your workstation.
Printer Upgrades	Allows you to upgrade your printer from your workstation.

CentreWare Sun OS/Solaris Services are also available to allow you to set up queues and also contain your printer drivers for Sun OS/Solaris.

All the CentreWare DP software and documentation is on your Printer Management Software CD.

CentreWare Internet Services

CentreWare Internet Services is an interactive service that extends the capabilities of CentreWare DP using Internet technology as the platform. It provides another option for implementing advanced services for the installation, configuration, and management of your printer. Each of the features in CentreWare Internet Services can be accessed through familiar client-resident software interfaces, such as Netscape Navigator or Microsoft Internet Explorer browsers. Through a web browser, users and system administrators will be able to monitor the status of the printer, print HTML-based documents, and access context sensitive on-line assistance.

For system administrators, CentreWare Internet Services will provide a faster and more productive way to install and upgrade software on your printer and a wide range of supporting information on the Internet.

Setup

To set up your printer for Internet/Intranet access, you will need to do the following:

- Configure an IP address for the printer on your network. See “*IP Address*” (page 1-75 for Ethernet or page 1-89 for Token Ring).
- Enable the embedded HTTP server at the Control Panel. See “*HTTP Enable*” (page 1-74 for Ethernet or page 1-88 for Token Ring).

To use the MaiLinx Mail Send and Mail Receive capability, you will need to establish a mail account for the printer and may need to install and configure the Xerox Mail Port Monitor.



See the Technical Information Guide, the CentreWare Internet Services User Guide, and online help for more information on the operation and use of CentreWare Internet Services.

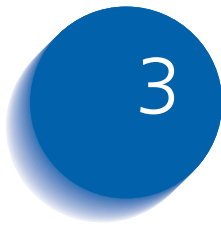

Using the Hard Drive and Flash Memory

<i>Hard Drive/Flash Memory Considerations</i>	3-2
<i>Disk Initialization</i>	3-2
<i>Flash Initialization</i>	3-2
<i>Downloading Fonts, Forms and Macros (Overlays)</i>	3-3
<i>FSDOWNLOAD Command</i>	3-4
<i>FSDELETE Command</i>	3-7
<i>Using the Hard Drive for Secure and Proof Jobs</i>	3-8
<i>Creating Secure Jobs</i>	3-8
<i>Creating Proof Jobs</i>	3-10
<i>Printing or Deleting Secure or Proof Jobs</i>	3-12

Hard Drive/Flash Memory Considerations

If you install the optional hard drive in the printer, it will significantly increase the amount of memory available for processing jobs and storing downloaded information (such as fonts, forms, overlays (macros) and secure jobs).

The hard disk is used for the following:

- Support of the PostScript file system.
- Support of the PJJL/PCL file system.
- Receiving raw (i.e., unprocessed) data for secure jobs, proof jobs, and collated copy jobs.
- Downloading fonts, forms, and overlays.

Disk Initialization

The disk is preformatted and requires no initialization. The disk may be returned to its initial state, with no loaded fonts, macros or secure jobs, by selecting the **Disk Initialize** item from the Reset Menu or from CentreWare DP.

Flash Initialization

Flash memory requires formatting before the first use. Formatting may be done by selecting the **Flash Format** item from the Reset Menu .

Downloading Fonts, Forms and Macros (Overlays)

The printer drivers provide you with the ability to download fonts and PCL 5e macros (overlays) to the printer.

Fonts, forms and macros can be downloaded to printer memory, to the optional hard drive and to optional flash memory via drivers.

- To download fonts you must first install the appropriate Windows, Macintosh, Windows NT, or UNIX drivers. To download macros, you must install the Windows PCL 5e driver.
- Fonts downloaded to the hard drive are stored in the PCL Fonts and PS Fonts directories. Macros downloaded to the hard drive are stored in the PCL Macros directory. Fonts, forms and macros stored in these directories remain there until you delete them. They are not cleared from the hard disk when the printer is powered off. You can only delete a macro from the hard disk if you know the name of the macro. Since you cannot print a list of macros as you can for fonts, it is important to keep a record of all downloaded macros. Then, use the PJP FSDELETE command to delete fonts, forms and macros.
- “Temporary” fonts/forms/macros downloaded to printer memory on a job per job basis are cleared from the printer's memory after each job.
- “Permanent” fonts downloaded to printer memory are cleared from memory whenever the printer is powered off. When the printer switches PDLs, its automatic State Saving feature saves all fonts and macros.

In addition to downloading through drivers, the printer will support downloading of fonts, forms and macros to its disk or flash memory by the use of the PJP command FSDOWNLOAD. These files may be deleted from the hard drive by the PJP command FSDELETE.

FSDOWNLOAD Command

The FSDOWNLOAD command is used to download fonts or macros to the printer's file system. If a file with the same name exists, the downloaded file overwrites it.

Syntax

```
@PJL FSDOWNLOAD FORMAT:BINARy [SIZE=int] [NAME = "pathname"] [<CR>]
<LF><binary data><ESC>%-12345X
```

Parameters

Parameter	Functional Range	Default
SIZE= <i>integer</i>	0 to 2 ³¹ - 1	N/A
NAME=" <i>pathname</i> "	ASCII 01 thru 255	N/A

SIZE = *integer* — The size variable indicates the number of bytes in the file to be downloaded. The size indicates the number of bytes immediately following the <LF> to the next UEL command.

NAME = "*pathname*" — where "*pathname*" = 0:\pcl\fonts*<fontname>* to download a font named "*fontname*" to the printer or = 0:\pcl\macros*<macroname>* to download a macro named "*macroname*" to the printer. *<fontname>*/*<macroname>* can be any combination of up to 40 alphanumeric characters.

<binary data> — This is the binary file data to be downloaded, such as font files and macro data.



Use of 1 rather than 0 in the "pathname" will download the font or macro to the Flash memory rather than to the hard drive.

The following is a sequence of commands that can be sent to the printer to download a macro to the disk. In this example, the macro is named “a_macro.”

```
<ESC>%-12345X @PJL<CR><LF>  
@PJL FSDOWNLOAD FORMAT:BINARY NAME = "0:\pcl\macros\a_macro" SIZE=29<CR><LF>  
<ESC>*p900x1500YThis is the macro <ESC>%-12345X
```

In this example:

- <ESC>%-12345X is the PjL UEL command which starts this sequence.
- @PjL<CR><LF> is the mandatory PjL command following the UEL command.
- @PjL FSDOWNLOAD... downloads a macro of 29 bytes named “a_macro.”
- The phrase “This is the macro” is positioned at x=900 and y=1500 by this macro.
- <ESC>%-12345X is the UEL command which ends this sequence.

Executing this macro requires the following PCL sequence:

<ESC>&n8W<HEX'04'>new_mac<CR,LF>	Sets the current macro ID to the string ID “new_mac”
<ESC>&n8W<HEX'05'>a_macro<CR,LF>	Associates the current macro ID with the supplied string ID
<ESC>&f2x<CR,LF>	Executes this macro

Notes:

- The macro ID must be the same case as in the original download command.
- The byte count (after the “n” and before the “W”) must equal the ID byte count plus 1.

The following is a sequence of commands that can be sent to the printer to download a font to the disk.

```
<ESC>%-12345X @PJL<CR><LF>  
@PJL FSDOWNLOAD FORMAT:BINAR NAME ="0:\pcl\fonts\font1" SIZE=XX<CR><LF>  
<binary data><ESC>%-12345X
```

In this example:

- <ESC>%-12345X is the PjL UEL command which starts this sequence.
- @PjL<CR><LF> is the mandatory PjL command following the UEL command.
- @PjL FSDOWNLOAD... downloads a font named "font1" that is "XX" bytes in size.
- <ESC>%-12345X is the UEL command which ends this sequence.
- Invoking this font requires the following PCL sequence:

<ESC>&n6W<HEX'00'>font2<CR,LF>	Sets the current font ID to the given string ID "font2"
<ESC>&n6W<HEX'01'>font1<CR,LF>	Associates the current font ID with the string ID "font1"
<ESC>&n6W<HEX'02'>font1<CR,LF>	Selects the font referred to as "font1" for the primary font

Notes:

- The case of the string ID must be the same as the case of the fontname in the FSDOWNLOAD command.
- The byte count ("6" in the above example) must equal the string ID byte count plus 1.

FSDELETE Command

The FSDELETE command is used to delete files from the printer's hard drive.

Syntax @PJL FSDELETE NAME = "*pathname*" [<CR>] <LF>

Parameters

Parameter	Functional Range	Default
NAME=" <i>pathname</i> "	ASCII 01 thru 255	N/A

NAME = "*pathname*" — where "*pathname*" has the same parameters as the FSDOWNLOAD command (see page 3-4).

Using the Hard Drive for Secure and Proof Jobs

Secure, collated copy, and proof jobs that have been submitted to the printer are stored in PCL or PostScript format on the hard drive. These secure and proof jobs can be printed (or deleted) through the Password Menu where you enter the 4-digit password for the job or jobs to be printed. Procedures for printing or deleting secure jobs are listed in Table 1.8 on page 1-19.

The secure or proof job is placed at the top of the print queue, and will print following completion of the currently printing job. If more than one job is requested, jobs are placed on the print queue in the order requested. Secure or proof jobs having the same priority are printed on a first in, first out basis.

Creating Secure Jobs

Secure printing delays printing of a job until a password associated with the job is entered at the printer's Control Panel. Entering the password at the Control Panel will provide access to only those jobs sent with that password.

Secure jobs are normally created in PCL and PostScript by choosing the feature in a driver. When not using a driver, secure jobs may be created by preceding the job with the following PJI commands:

```
@PJI XSECUREJOB  
@PJI XJOBPASSWORD = "number"
```

These commands must be immediately followed by a standard PJI "JOB" command that includes the "jobname."

Job names can be up to 16 alphanumeric characters and passwords must contain four numeric characters (0-7). The printer assigns a default job name if no name or a name with a syntax error is used. The job name is displayed on the Control Panel Password menu when the associated password is entered. If a password is not assigned or the password contains syntax errors, the job is not printed and is discarded.

The following example creates a Secure Job named "Bond" with a password of 0007:

```
<ESC>%-12345X@PJL XSECUREJOB
@PJL XJOBPASSWORD = 0007
@PJL JOB NAME = "Bond"
@PJL ENTER LANGUAGE = PCL
...PCL file...
<ESC>%-012345X@PJL EOJ
<ESC>%-012345X
```

The printer processes all data following the @PJL ENTER LANGUAGE = PCL command as part of the Secure Job named "Bond." The job is stored on the hard disk under the name "Bond" with a password of "0007" as defined in the @PJL XJOBPASSWORD command. The @PJL EOJ command signifies the end of the secure job. The EOJ command should be followed by a UEL command.

Creating Proof Jobs

Proof printing lets you print a single copy of a multiple copy job. You assign a password and copy count at your workstation or computer before printing. The first set is printed immediately. You can then go to the printer and proofread (proof) the first set. Depending on the outcome of the proofing, you can then decide either to continue printing the sets or to delete the job after entering your password at the printer's Control Panel.

Proof jobs, if not sent by a driver with the proof job feature, may be invoked in both PCL and PostScript by preceding the job with the following PJJL commands:

```
@PJJL XPROOFJOB  
@PJJL XJOBPASSWORD = number
```

These commands must be immediately followed by a standard PJJL "JOB" command that includes the "jobname".

The printer continues processing all subsequent data as part of the proof job of name "jobname." The proof job is stored with the name "jobname" and associated with the password defined in the PJJL XJOBPASSWORD command. The proof job ends when the PJJL End of Job command is received (i.e., @PJJL EOJ). The "EOJ" command should be followed by a UEL.

The job name is limited to 16 alphanumeric characters in the range ASCII 30 through ASCII 255, <SP> and <HT>. The password must contain four numeric characters in the range ASCII 48 through ASCII 55. The printer assigns a default job name if no name or a name with a syntax error is called out. The job name is the name displayed on the Control Panel Password Menu when the associated password is entered. If no password is assigned or there is a password syntax error, the entire job is printed immediately and is not stored as a proof job.

The following example creates a PCL proof job with the name "Sample" associated with password 7777 requesting five collated sets.

```
<ESC>%-12345X@PJL XPROOFJOB
@PJL XJOBPASSWORD = 7777
@PJL JOB NAME = "Sample"
@PJL ENTER LANGUAGE = PCL
@PJL SET QTY = 5
...PCL file...
<ESC>%-012345X@PJL EOJ
<ESC>%-012345X.
```

Printing or Deleting Secure or Proof Jobs

Secure or proof jobs may be printed or deleted by using the Password Menu, as described in the section “*Password Menu*” (page 1-19). They may also be deleted by using the Delete Jobs function in the Reset Menu, as described in the section “*Reset Menu*” (page 1-109).



Collated set jobs can be created in the same manner as proof or secure jobs by using the “Select Collated Sets” PjL command (@PJL SET QTY...).

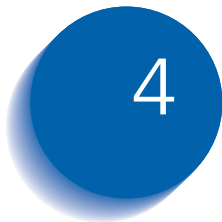

Maintaining the Printer

<i>Regular Printer Maintenance</i>	4-2
<i>Cleaning the Printer</i>	4-2
<i>Replacing the Laser Print Cartridge</i>	4-3
<i>Maintenance Kit Instructions</i>	4-6
<i>Replacing the Feed Rollers</i>	4-7
<i>Replacing the Bias Transfer Roller</i>	4-11
<i>Replacing the Fuser Assembly</i>	4-14

Regular Printer Maintenance

Your printer is designed to need very little ongoing maintenance other than the replacement of maintenance items as they reach their end of use. It is recommended that maintenance items be replaced when the end of use warnings appear on the Control Panel to avoid untimely image quality problems. However, it is always good practice to periodically clean any loose toner or foreign matter in your printer.



For optimum performance:

- *Keep the printer out of direct sunlight. Faded images, light areas or dark bands may result.*
 - *Do not place the printer near vents or dust-producing equipment. Particles in the air may enter the printer and cause failures in internal mechanisms.*
-

Cleaning the Printer



Power off the printer before cleaning.

For best results, clean the outside of the printer with a damp cloth. Do not use detergents.

When replacing the laser print cartridge or components of the maintenance kit, check the inside of the printer. Remove any paper scraps and wipe off paper dust using a dry, clean cloth.

Replacing the Laser Print Cartridge

When the laser print cartridge runs low on toner, the printer's Control Panel display will read **Toner Low**. You should replace the laser print cartridge soon after this message appears to avoid loss of print quality. This is a simple procedure, described on the following pages.



- *Do not expose the laser print cartridge to direct sunlight or artificial light for more than 15 minutes. Overexposure will permanently damage the photosensitive imaging drum.*
- *Do not open the drum shutter (see Figure 4.1 below) or touch the blue imaging drum surface.*

Figure 4.1 Drum Shutter Location

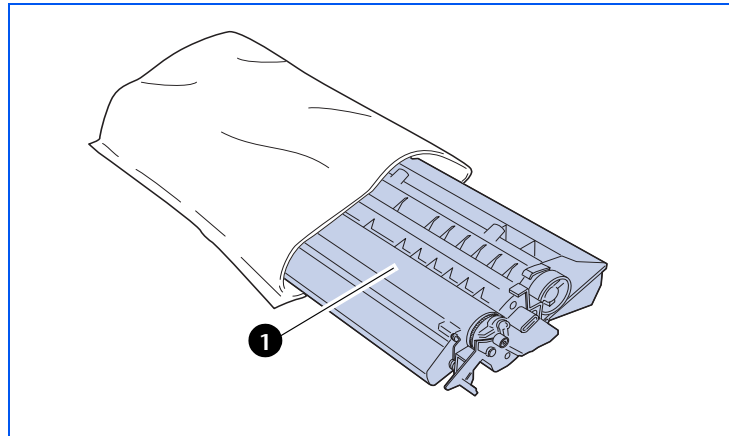

1 Drum shutter

To replace the laser print cartridge, follow these steps:

- 1 If the envelope feeder is installed, power off the printer and remove the envelope feeder.
- 2 Remove any paper from the output bin and multi bypass feeder, and close the multi bypass feeder.
- 3 Open the front cover all the way until it stops.

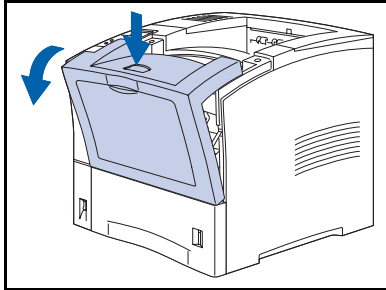

Do not touch any parts inside the printer.

- 4 Slowly lift up and pull out the used laser print cartridge.

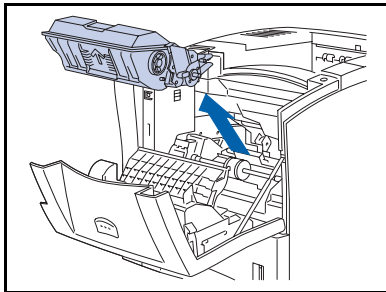

To prevent toner stains, place the cartridge on a surface covered with scrap paper.

- 5 Remove a new laser print cartridge from its packaging and shake the cartridge seven to eight times, as shown, to loosen the toner.

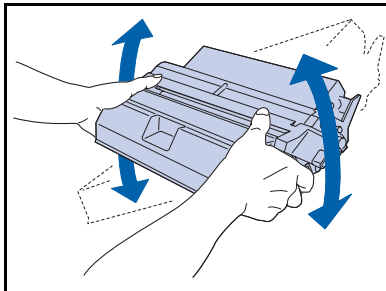

Be sure to shake the laser print cartridge when directed to distribute the toner inside the cartridge. Print quality may be degraded if the toner is not evenly distributed. If the toner has not been properly freed by shaking the cartridge, you may hear a noise when powering on the printer, and the cartridge may be damaged.

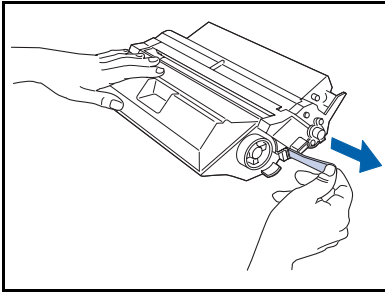

- 6** Place the cartridge on a flat surface, hold it firmly with one hand and with the other hand grasp the end tab of the sealing tape and pull the tape straight out horizontally.

! **If pulled at an angle, the tape may break. After pulling out the tape, do not shake the cartridge or subject it to shocks.**

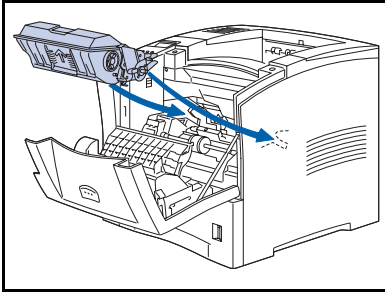

- 7** Holding the cartridge as shown, lower it into the printer, inserting the cartridge's two projecting parts into the printer's guide channels.

➡ **Be sure to push the cartridge all the way into the printer.**

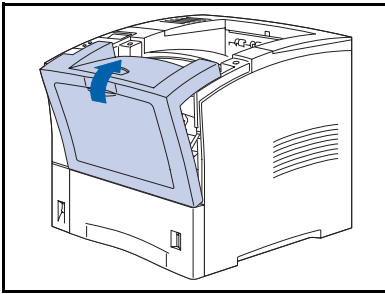

- 8** Slowly close the front cover. Press the center part of the top cover until it latches into place.

- 9** If the envelope feeder was removed, reinstall it and power on the printer.

- 10** Check the Control Panel display. Wait until **Ready** is displayed. If an error message appears, refer to Table 5.1 on page 5-4 for instructions.

- 11** Recycle the used cartridge using the packaging from the new cartridge, following the directions provided.

Maintenance Kit Instructions

The life expectancy of the maintenance kit components is approximately 200,000 sheets. When that number is reached, a message will appear on the Control Panel notifying you that it is time to install the maintenance kit.

The maintenance kit consists of:

- feed rollers (3)¹
- bias transfer roller (BTR)
- fuser assembly
- cleaning cloth
- installation instructions.



If you misplace the maintenance kit installation instructions, contact Customer Support Center or your service provider for a replacement.

Use the installation instructions that come with the maintenance kit to install the complete kit and reset the maintenance counter. Should you need to install individual components of the kit, you can use the instructions on the following pages.

1. If optional feeder trays are installed, additional feed rollers are available for them. Contact your service provider.

Replacing the Feed Rollers

The feed rollers are used for transporting the print media from the feeder into the printer.

To replace the feed rollers with new ones, follow the steps listed below.



To avoid electric shock, be sure to power off and unplug the printer before beginning this procedure.

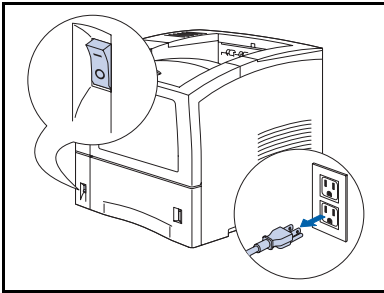

- 1 Power off the printer and disconnect the power cord.

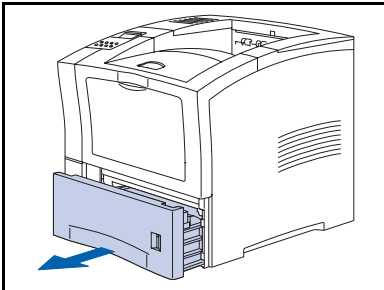

- 2 Remove Tray 1.

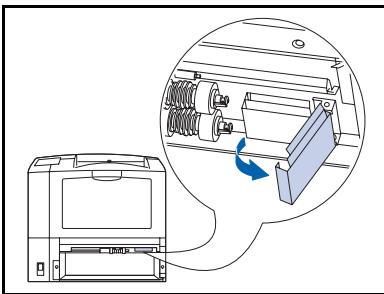

- 3 Pivot the hinged metal plate down and hold.

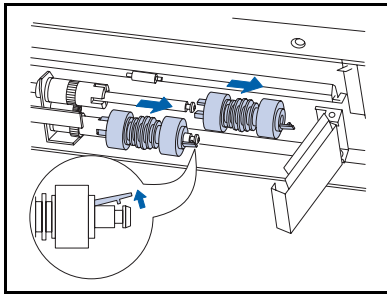

- 4** Unclip the retaining tabs on the ends of the two feed rollers and slide the rollers off of their shafts.

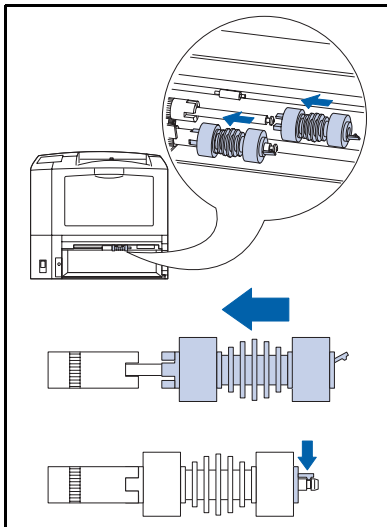

- 5** Slide the new rollers onto the shafts until their retaining clips lock into place.

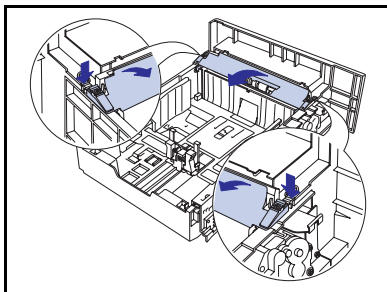

- 6** Flip open the metal plate on the paper tray by pushing on the tabs and lifting up the orange grips.

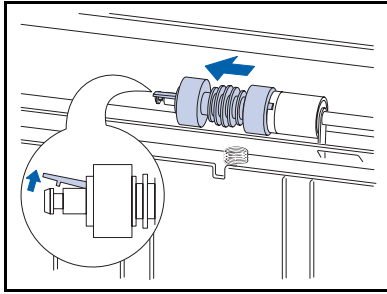

- 7** Unclip the retaining tab on the end of the feed roller and slide the roller off of its shaft.

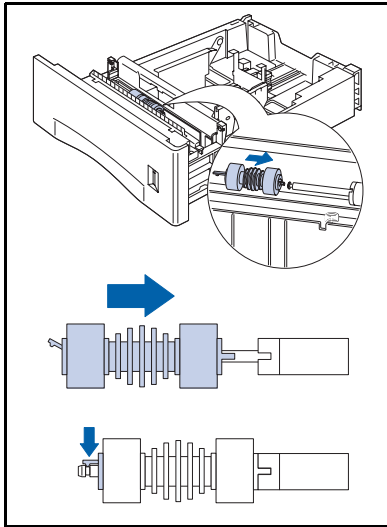

- 8** Slide the new roller onto the shaft until its retaining clip locks into place.

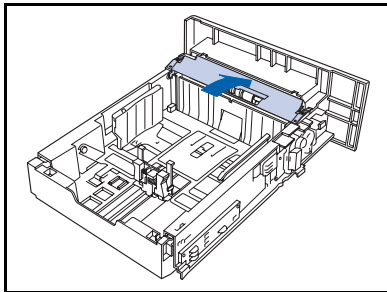

- 9** Flip down the metal plate and push on the orange grips until the plate locks into place.

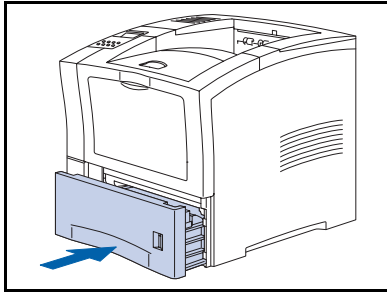

- 10 Reinstall the tray in the printer.
- 11 Reconnect the power cord and power on the printer.
- 12 Check the Control Panel display. Wait until **Ready** is displayed. If an error message appears, refer to Table 5.1 on page 5-4 for instructions.

Replacing the Bias Transfer Roller

The bias transfer roller is used for transferring toner onto paper. Replacement is recommended at intervals of 200,000 sheets.

To replace the bias transfer roller with a new one, follow the steps listed below.



To avoid electric shock, be sure to power off and unplug the printer before beginning this procedure.

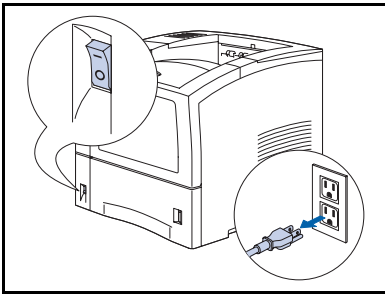

- 1 Power off the printer and disconnect the power cord.

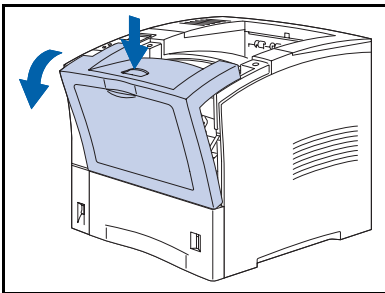

- 2 Open the front cover.

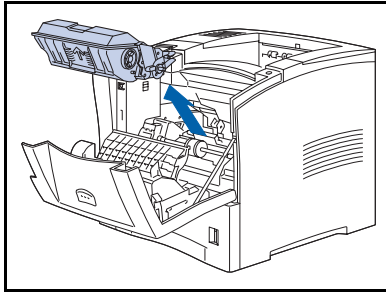

- 3 Remove the laser print cartridge.



To prevent toner stains, place the cartridge on a surface covered with scrap paper.

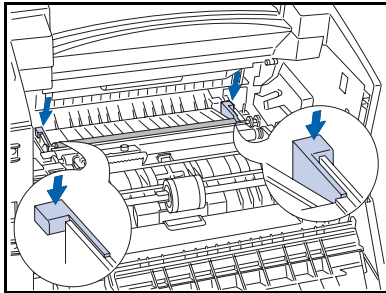

- 4 Press the orange levers down to raise the roller.

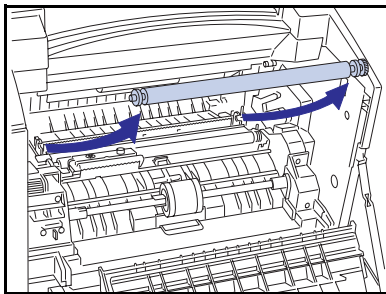

- 5 While holding both ends of the roller, pull it towards you and lift it out.



Do not reach into the area behind the roller where a printer component has a serrated edge.

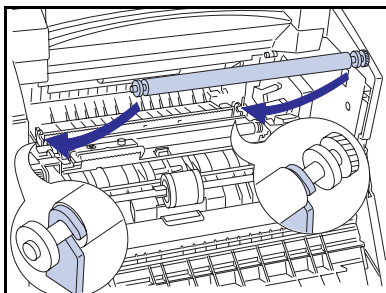

- 6 Hold the new roller at each end with the gear on the right. Align the roller's ends with the right and left notches, then gently press the roller into place, one side at a time.



Be careful not to touch the roller.

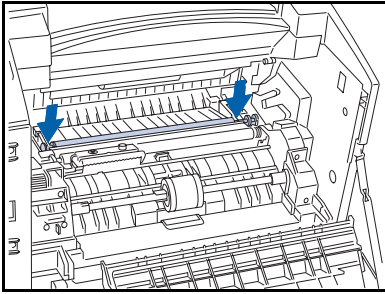

- 7 Make sure the roller shaft is seated in the notches, then press down firmly until it locks in place.

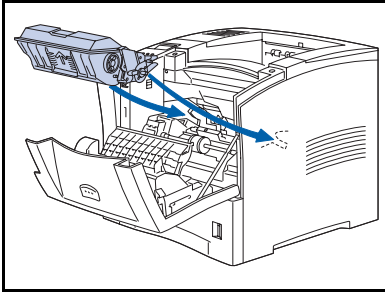

- 8 Reinstall the laser print cartridge.

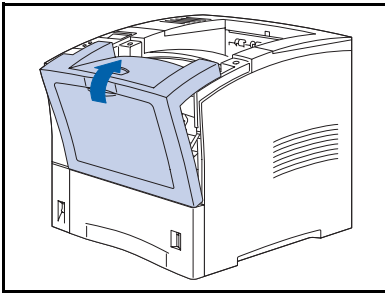

- 9 Close the front cover.
- 10 Reconnect the power cord and power on the printer.
- 11 Check the Control Panel display. Wait until **Ready** is displayed. If an error message appears, refer to Table 5.1 on page 5-4 for instructions.

Replacing the Fuser Assembly

The fuser is used for fusing toner onto paper, and has a life expectancy of approximately 200,000 impressions (though, depending on how the printer is used, it may require replacement before that number is reached).

To replace the fuser with a new one, follow the steps listed below.



To avoid electric shock, be sure to power off and unplug the printer before beginning this procedure.



To avoid burns, wait at least 40 minutes after powering off the printer to allow the fuser to cool down, and observe warning labels inside the printer.

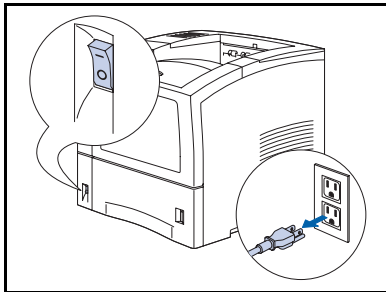

- 1 Power off the printer and disconnect the power cord.

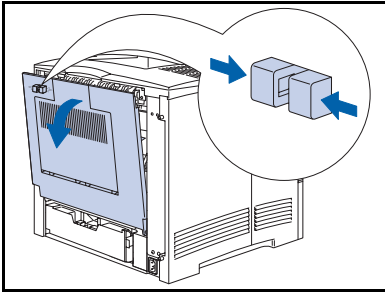

- 2 After waiting for the fuser to cool down, open the rear cover.

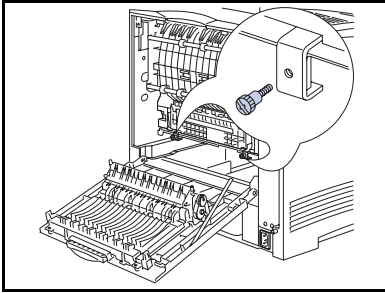

- 3 Remove the screws that secure the fuser.



If the duplex module is installed, you will first need to remove it by pushing in on the two green levers to slide the unit out.

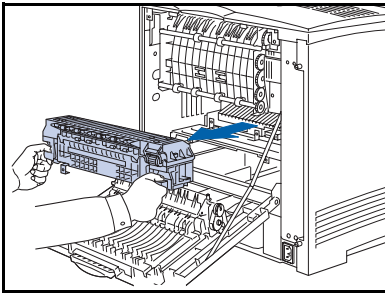

- 4 Grasp the fuser by the orange tabs and slide it out of the printer.

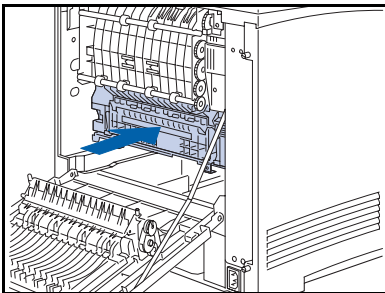

- 5 Slide the new fuser into the printer. Make sure it is seated securely.

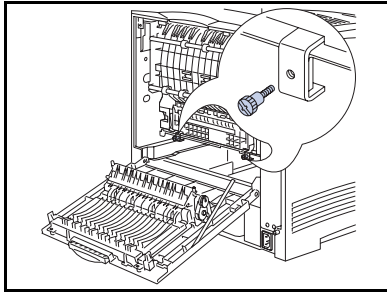

6 Install the fuser screws and hand tighten.



Install the duplex module, if removed in Step 3, by sliding the unit in until the green levers snap into place.

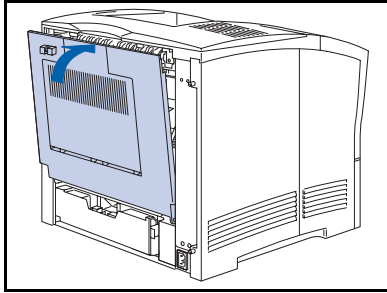

7 Close the rear cover.



If you are installing the entire maintenance kit (fuser, bias transfer roller and feed rollers), refer to the installation instructions that came with your kit to reset the maintenance counter. If you have misplaced the maintenance kit instructions package, contact Customer Support.

8 Reconnect the printer's power cord and power on the printer.

9 Check the Control Panel display. Wait until **Ready** is displayed. If an error message appears, refer to Table 5.1 on page 5-4 for instructions.



Troubleshooting

Before You Begin Troubleshooting 5-2
Control Panel Messages 5-4

Before You Begin Troubleshooting

If it becomes necessary for you to take corrective actions, note the following safety tips and then begin your troubleshooting by checking for possible hardware, software, and printer maintenance issues.



Do not use tools or sharp objects to clear paper jams since this may damage the printer. Do not touch the surface of the Print Drum or the Transfer Roller. Touching these surfaces may damage them.



Avoid contact with the printer's fuser area, which may be hot.

Also, be sure to observe the safety guidelines and recommendations provided in the Safety Notes.

If your printer is not operating properly, make sure that the following hardware and software issues have been considered.

Hardware

- Is the printer plugged in?
- Is the printer switched on?

Software

- Is the correct printer driver installed and selected for your printer configuration?

Printer Maintenance

An improperly seated tray or an open cover will prevent printing. You can avoid these problems by regularly taking the following precautions.

- Insert media trays properly and securely.
- Keep covers securely closed.

Consumables

An empty laser print cartridge or expended maintenance item may result in poor print quality or prevent printing.

- Keep consumables and maintenance items in supply.
- Add or replace when prompted by printer.



Specific instructions for replacing each consumable and maintenance item are included with the individual replacement packages.

Control Panel Messages

Listed in Table 5.1 are Control Panel messages that either:

- Cause the printer to stop printing.
- Require you to call for service.

Also included in Table 5.1 are common, non-error messages you are likely to see. The messages are listed in alphabetical order.

Table 5.1 Control Panel Messages

Message	Explanation/Corrective Action
Clear Paper Path	Part of a sequence of messages following an initial paper jam message. Remove any jammed paper from the exposed paper path, close covers, then refer back to the Control Panel for further messages.
Close Front Cvr	The front cover is open. Close it to resume printing.
Close Rear Cvr	The rear cover is open. Close it to resume printing.
Disk Error Format Disk	Displayed when a Hard Disk error is found. Reformat the disk as per the instructions for "Disk Format" (page 1-109). If the problem persists, contact your service provider.
Disk Full	When the hard disk is full as a result of a secure or proof job spooling, the job is canceled and deleted after printing the first copy of the partial job.
Download Failed Please Reboot	The downloading process has failed and the printer must be rebooted to recover.
Download Passed Please Reboot	The downloading process has passed and the printer must be rebooted for changes to take effect.
Downloading Please Wait	The printer is in downloading mode. Wait until download completes for further messages.

Table 5.1 Page 1 of 8

Table 5.1 Control Panel Messages (continued)

Message	Explanation/Corrective Action
Duplex Unit Fail (or Removed)	The duplex unit has failed or has been removed. Printing using this device cannot resume until reinstalled or repaired. If the problem persists, contact your service provider.
Enter Password	The Password Menu has been invoked and entry of a password is requested.
Env. Feeder Fail (or Removed)	The Envelope Feeder is detached or has failed. Printing using this device cannot resume until reinstalled or repaired. If the problem persists, contact your service provider.
Env. Feeder Jam Remove All Envel	A paper jam has occurred when feeding from the Envelope Feeder. Remove all envelopes, then refer back to the Control Panel for further messages.
Exit Jam- Open Rear Cover	A paper jam has occurred at the exit path to output bin. Open the printer's rear cover, then refer back to the Control Panel for further messages.
Face Up Bin Open	The face up bin is open while the duplex unit is being selected. Close the face up bin to resume printing.
Flash Error Format Flash	Displayed when Flash Memory error is found. Format flash memory as per the instructions for "Flash Format" (page 1-109). If the problem persists, contact your service provider.
Format Failed Disk Locked	The printer cannot format the disk because the disk has been locked via a PjL or SNMP command.
Fuser Failure Power Off/On	The fuser assembly has failed or is not installed. Printing cannot resume. Power off and power on the printer. If the problem persists, contact your service provider.
Table 5.1 Page 2 of 8	

Table 5.1 Control Panel Messages (continued)

Message	Explanation/Corrective Action
Init Failed Disk Locked	The printer cannot put the disk in factory default condition because an attempt has been made to initialize the disk after it has been locked via a PJI or SNMP command.
Initializing... Flash Memory	The printer is initializing the flash memory.
Insert Tray 1	The printer cannot feed from Tray 1 because the tray is open or removed. Reinstall/insert the tray to resume printing.
Insert Tray 2	The printer cannot feed from Tray 2 because the tray is open or removed. Reinstall/insert the tray to resume printing.
Insert Tray 3	The printer cannot feed from Tray 3 because the tray is open or removed. Reinstall/insert the tray to resume printing.
Install Print Cartridge	The laser print cartridge is missing or is not installed correctly. Install the laser print cartridge according to the directions for "Replacing the Laser Print Cartridge" (page 4-3).
IOT NVM Fail Power Off/On	The NVM (Non Volatile Memory) has failed on the IOT (Image Output Terminal) which is also called the print engine. Printing cannot resume. Menu operations may have to be halted if this error occurs. Power off and power on the printer. If the problem persists, contact your service provider.
Laser Failure Power Off/On	The laser assembly has failed. Power off and power on the printer. If the problem persists, contact your service provider.
Load Env. Feeder Size and Type	Load paper of the size and type shown into the Envelope Feeder.

Table 5.1 Page 3 of 8

Table 5.1 Control Panel Messages (continued)

Message	Explanation/Corrective Action
Load MBF <i>Size and Type</i>	Load paper of the size and type shown into the multi bypass feeder.
Load Tray 1 <i>Size and Type</i>	Load paper of the size and type shown into Tray 1.
Load Tray 2 <i>Size and Type</i>	Load paper of the size and type shown into Tray 2.
Load Tray 3 <i>Size and Type</i>	Load paper of the size and type shown into Tray 3.
Maintenance Kit Replace	The fuser count has reached 200,000 sheets (at end of life). The printer shuts down after the job. The printer will continue to print, but over time print quality will deteriorate. Replace the maintenance kit and reset the maintenance counter as per the instructions provided in the kit.
Manual Feed <i>Size and Type</i>	Load paper of the size and type shown into the multi bypass feeder.
MBF Jam- Remove All Paper	A paper jam has occurred while feeding from the multi bypass feeder. Remove all paper from the multi bypass feeder, then refer back to the Control Panel for further messages.
Memory Failure Power Off/On	Controller memory has failed. Printing cannot resume. Power off and power on the printer. If the problem persists, contact your service provider.
Menu Locked	Appears on the bottom line of the display when a selected menu is locked by the network administrator using a PjL command. Users are prohibited from making any changes to the configuration parameters in the menu.

Table 5.1 Page 4 of 8

Table 5.1 Control Panel Messages (continued)

Message	Explanation/Corrective Action
Motor Failure Power Off/On	The main motor assembly has failed. Printing cannot resume. Power off and power on the printer. If the problem persists, contact your service provider.
No Jobs Press Menu	The Password Menu has been invoked, a password has been entered, and there are no secure jobs in the print queue for that password.
NV Memory Fail Power Off/On	Controller NVRAM has failed. Printing cannot resume. Menu operations may have to be halted if this error occurs. Power off and power on the printer. If the problem persists, contact your service provider.
Offset Bin Fail Power Off/On	The Offset Bin (Offset Catch Tray) has failed. Printing using this bin cannot resume. Power off and power on the printer. If the problem persists, contact your service provider.
Offline	The printer is offline. Press the Online button to bring the printer online.
Offset Jam- Open Rear Cover	A paper jam has occurred at the Offset Catch Tray. Open the printer's rear door, then refer back to the Control Panel for further messages.
Open Front Cover Remove Jam Sheet	Part of a sequence of messages following an initial paper jam message. Open the front cover, clear any jammed paper there, then refer back to the Control Panel for further messages.
Open Offset Door Clear Paper Path	Part of a sequence of messages following an initial paper jam message. Open the Offset Catch Tray's rear door, clear any jammed paper there, then refer back to the Control Panel for further messages.
Out of Memory	The printer is out of memory while processing a job, and will resume printing when memory is freed up.
Paper Jam- Open Front cover	A paper jam has occurred inside the front cover. Open the printer's front cover, then refer back to the Control Panel for further messages.

Table 5.1 Page 5 of 8

Table 5.1 Control Panel Messages (continued)

Message	Explanation/Corrective Action
Paper Jam- Open Rear cover	A paper jam has occurred inside the rear cover. Open the printer's rear cover, then refer back to the Control Panel for further messages.
Paper Size Jam- Open Rear Cover	The size of the paper fed into the printer was not the size expected by the printer, causing a jam. Open the printer's rear cover, then refer back to the Control Panel for further messages.
Power Saver On	The printer is in Low Power Mode.
Processing... Config Sheet	The printer is generating and printing a Configuration Sheet.
Processing... DEMO	The printer is generating and printing a Demo Page.
Processing... Disk Directory	The printer is generating and printing a disk directory.
Processing... Fault History	The printer is generating and printing a fault history log.
Processing... Menu Map	The printer is generating and printing a menu map.
Processing... PCL Font List	The printer is generating and printing a PCL font list.
Processing... PostScript	The printer is generating and printing a PostScript font list.
Processing... TEST	The printer is generating and printing a Test Print.
Table 5.1 Page 6 of 8	

Table 5.1 Control Panel Messages (continued)

Message	Explanation/Corrective Action
Ready	The printer is online and ready to print.
Remove DuplxUnit Clear Paper Path	Part of a sequence of messages following an initial paper jam message. Remove the duplex unit and any jammed paper, then refer back to the Control Panel for further messages.
Remove EnvFeeder Open Front Cover	Part of a sequence of messages following an initial paper jam message. Remove the Envelope Feeder and open the printer's front cover, then refer back to the Control Panel for further messages.
Remove Jam Envel	Part of a sequence of messages following an initial paper jam message. Remove any jammed envelopes, then refer back to the Control Panel for further messages.
Remove Output From Offset Bin	The Offset Bin (Offset Catch Tray) is full. Empty the bin to resume printing.
Remove Output From Std. Bin	The Standard Bin is full. Empty the bin to resume printing.
Remove PrintCart Clear Paper Path	Part of a sequence of messages following an initial paper jam message. Remove the laser print cartridge and any jammed paper, then refer back to the Control Panel for further messages.
Toner Low	The toner in the laser print cartridge is low. The printer will continue to print, but over time print quality will deteriorate. Replace the laser printer cartridge.
Tray 1 Failure Power Off/On	Tray 1 has failed. Power off and power on the printer. If the problem persists, contact your service provider.

Table 5.1 Page 7 of 8

Table 5.1 Control Panel Messages (continued)

Message	Explanation/Corrective Action
Tray 1 Jam- Open Tray 1	A paper jam has occurred at or before the input sensor when feeding paper from Tray 1. Remove Tray 1 from the printer, then refer back to the Control Panel for further messages.
Tray 2 Failure Power Off/On	Tray 2 has failed. Power off and power on the printer. If the problem persists, contact your service provider.
Tray 2 Jam- Open Tray 2	A paper jam has occurred at or before the input sensor when feeding paper from Tray 2. Remove Tray 2 from the printer, then refer back to the Control Panel for further messages.
Tray 2/3 Failure Power Off/On	Tray 2 or Tray 3 has failed. Printing using this tray cannot resume. Power off and power on the printer. If the problem persists, contact your service provider.
Tray 3 Failure Power Off/On	Tray 3 has failed. Power off and power on the printer. If the problem persists, contact your service provider.
Tray 3 Jam- Open Tray 3	A paper jam has occurred at or before the input sensor when feeding paper from Tray 3. Remove Tray 3 from the printer, then refer back to the Control Panel for further messages.
Waiting...	There are no more data in the data stream and the job (for PostScript) or the page (for PCL) is incomplete.
Table 5.1 Page 8 of 8	

6

Installing Printer Options

<i>Optional Equipment</i>	6-3
<i>550 Sheet Feeder</i>	6-6
<i>Precautions</i>	6-7
<i>Installing One Feeder</i>	6-8
<i>Installing Two Feeders</i>	6-11
<i>Removing a Feeder</i>	6-14
<i>Envelope Feeder</i>	6-16
<i>Installing</i>	6-16
<i>Removing</i>	6-17
<i>Offset Catch Tray</i>	6-18
<i>Installing</i>	6-18
<i>Removing</i>	6-20
<i>Face Up Bin</i>	6-22
<i>Installing</i>	6-22
<i>Removing</i>	6-24
<i>Duplex Module</i>	6-25
<i>Installing</i>	6-25
<i>Removing</i>	6-27

<i>Hard Disk Drive</i>	6-29
<i>Installing</i>	6-29
<i>Removing</i>	6-32
<i>Interface Card</i>	6-34
<i>Installing</i>	6-34
<i>Removing</i>	6-37
<i>Additional Memory</i>	6-40
<i>Installing or Removing</i>	6-40

Optional Equipment

The optional equipment described in this guide allows you to add special features to your printer or upgrade your printer system to meet your particular needs. Table 6.1 on page 6-4 provides a brief description of each enhancement available. The part number needed to place an order can be found on the *Supplies/Options Guide* that came with the printer.



Normally, the optional equipment kits come with installation instructions. For your convenience, the instructions are also included in this chapter.

To order any of the equipment listed below, see the separate *Supplies/Options Guide* or call your authorized Xerox reseller.

Table 6.1 Optional Equipment

Optional Kits	Use
550 sheet feeder	Allows the use of additional paper trays. Up to two feeders can be installed (for Trays 2 and 3).
Envelope feeder	Allows the loading of envelopes or postcards for automatic feeding into the printer.
Offset Catch Tray	Enables output of up to 500 sheets of paper with the ability to offset successive jobs (or multiple copies within the same job) from each other. Supplements the standard output bin.
Face up bin	Allows for printed output to exit the printer face up (minimizing curl). Provides a straight through path from the multi bypass feeder.
500 sheet universal cassette	Additional paper cassette for use with optional paper feeder.
Duplex Unit	Allows printing on both sides of the sheet of paper.
Hard Drive	Allows for secure job and proof job printing, storage of fonts and macros, and increases the productivity of multiple-page jobs via electronic pre-collation.
Ethernet 10Base2 Card (network-capable printer only)	Provides 10 MBPS 10Base2 Ethernet network capability for IPX/SPX, TCP/IP, DLC/LLC, SNMP and EtherTalk protocols.
Token Ring Card (network-capable printer only)	Provides network capability utilizing IPX/SPX, TCP/IP, DLC/LLC, SNMP and TokenTalk protocols.
Serial Card	Provides an RS232C interface, using a DB9 connector. The serial port is bidirectional—i.e., it can receive data from the computer as well as transmit data from the printer to the computer.

Table 6.1 Page 1 of 2

Table 6.1 Optional Equipment (continued)

Optional Kits	Use
Memory (DIMMs)	<p>Increases the font capability and enhances the speed of data transfer and complex page processing.</p> <p>Memory kits are available in three configurations, packaged in single units each:</p> <ul style="list-style-type: none"> - 64 MB - 32 MB - 16 MB <p>The printer utilizes industry standard DIMMs with the following specifications:</p> <ul style="list-style-type: none"> - 168 pin, 60 ns (or faster) DIMMs - 64 bit wide (non parity) - EDO
Flash Memory (DIMMs)	Provides 8 MB of memory for storage of downloaded fonts, forms and macros.

Table 6.1 Page 2 of 2

550 Sheet Feeder

You can install either one or two of these feeders, as shown in Figures 6.1 and 6.2.

Figure 6.1 One Feeder Installed

- 1 Tray 1 (standard feeder)
- 2 Tray 2 (optional feeder)

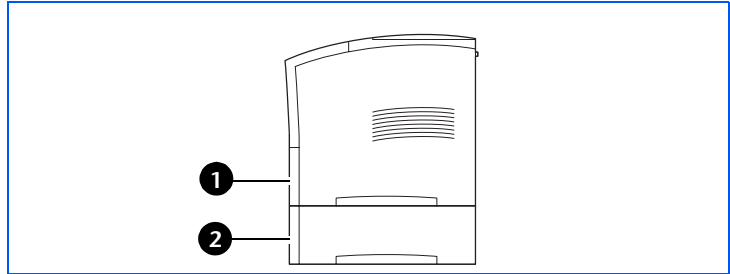
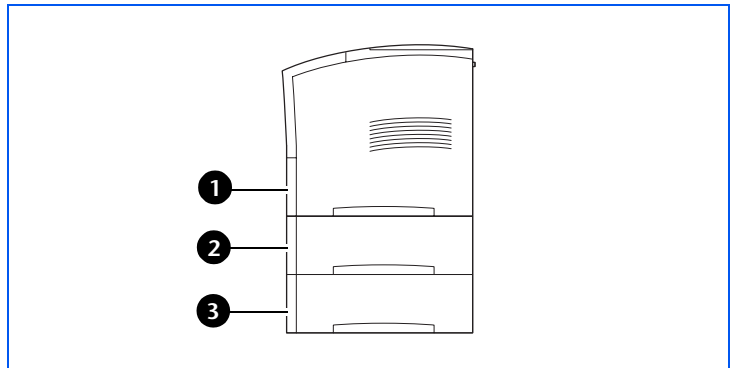

Figure 6.2 Two Feeders installed

- 1 Tray 1 (standard feeder)
- 2 Tray 2 (optional feeder)
- 3 Tray 3 (optional feeder)



Precautions



To avoid electric shock, be sure to power off and unplug the printer before accessing its interior for this procedure.



Never attempt to lift the printer by yourself. To lift the printer, have two people facing each other from the front and rear use the recessed hand grips as shown below.

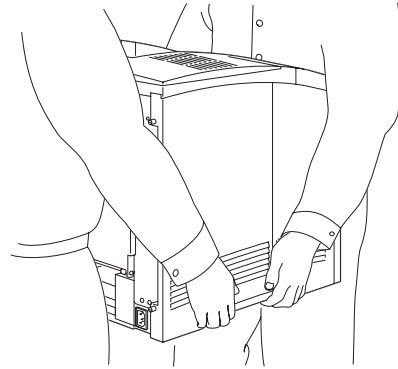

Do not move the printer once the paper feeder is installed.

Installing One Feeder

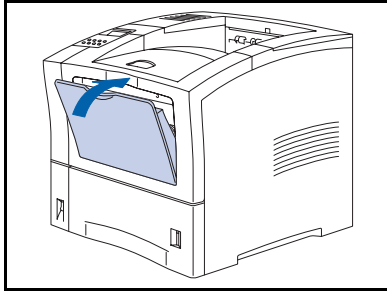

1 If the multi bypass feeder is open, close it.

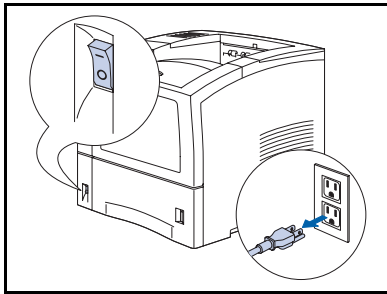

2 Power off the printer and disconnect the power cord from the power outlet and the printer.

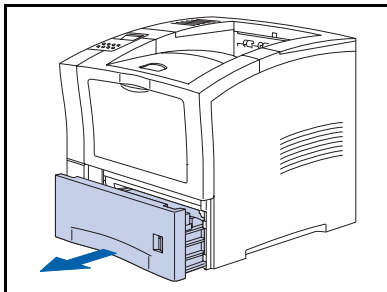

3 Lift up and out to remove the standard feeder (Tray 1) from the printer.

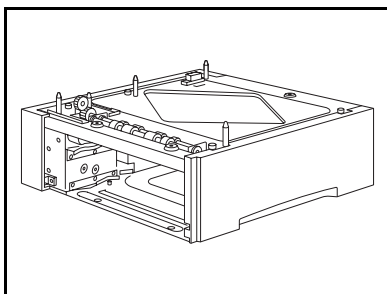

4 Place the optional feeder at the printer location.

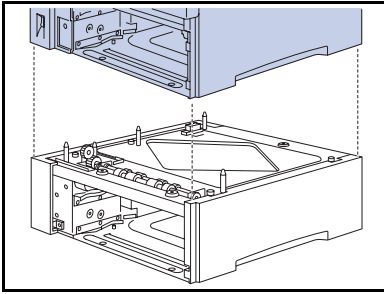

- 5** *Using two people*, gently lower the printer onto the feeder, aligning the four corners of the printer and feeder.



Lowering the printer too fast may damage internal components.

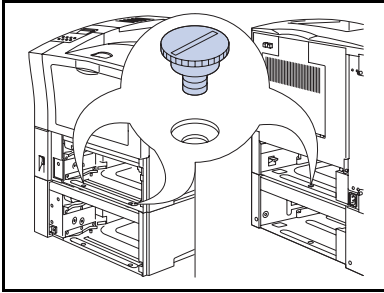

- 6** Secure the printer to the optional feeder with the three supplied screws (two in front, one in back).

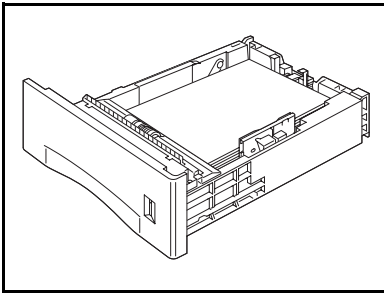

- 7** Load paper into the optional feeder's tray (refer to Chapter 2 of the *User Guide* for details, if necessary).

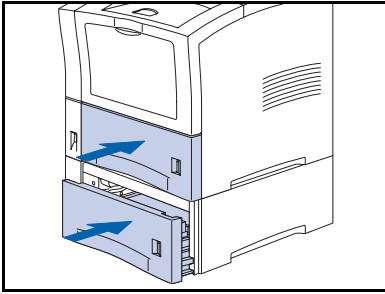

- 8 Insert the standard and optional trays into the printer, making sure they are properly seated.
- 9 Reconnect the printer's power cord and power on the printer.
- 10 Check the Control Panel display. Wait until **Ready** is displayed. If an error message appears, refer to Table 5.1 on page 5-4 for instructions.
- 11 If you have no other options to install, print a Configuration Sheet (see page 1-103) and check it to confirm that the option(s) have been properly installed.

Installing Two Feeders

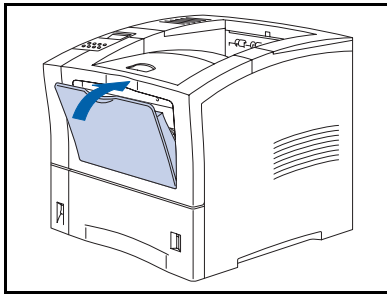

1 If the multi bypass feeder is open, close it.

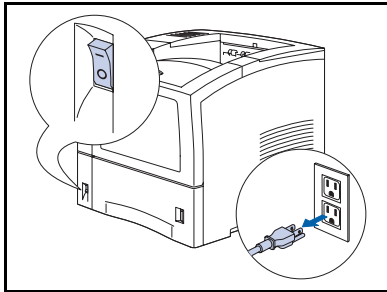

2 Power off the printer and disconnect the power cord from the power outlet and the printer.

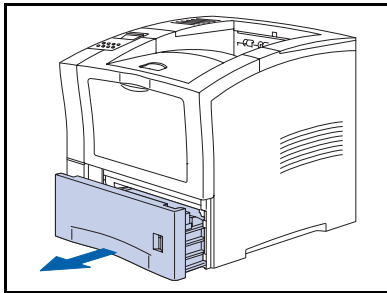

3 Lift up and out to remove the standard feeder (Tray 1) from the printer.

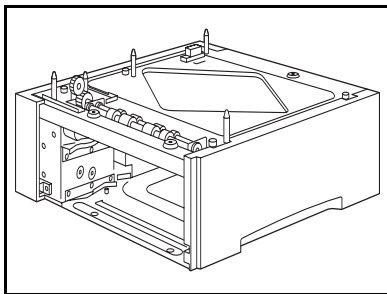

4 Place the optional feeder at the printer location.

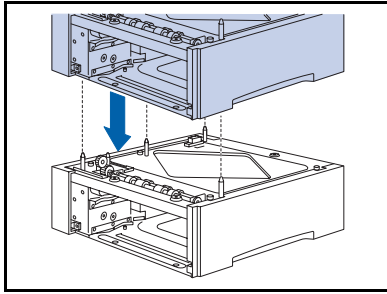

- 5 Stack the other optional feeder onto the bottom feeder, aligning the four corners of the top and bottom feeder.

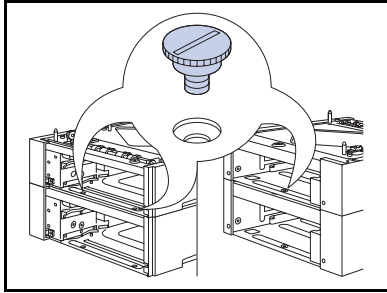

- 6 Secure the top feeder to the bottom feeder with the three supplied screws (two in front, one in back).

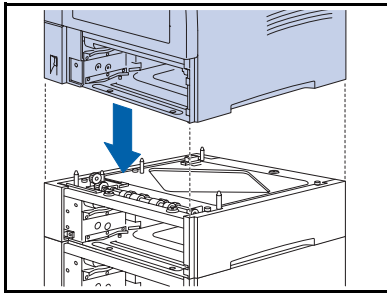

- 7 *Using two people*, gently lower the printer onto the top feeder, aligning the four corners of the printer and feeder.



Lowering the printer too fast may damage internal components.

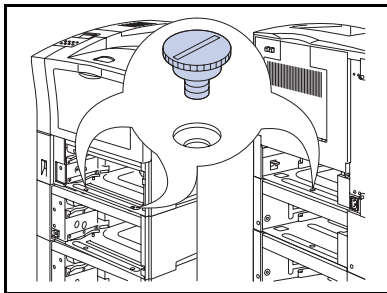

- 8 Secure the printer to the top feeder with the three supplied screws (two in front, one in back).

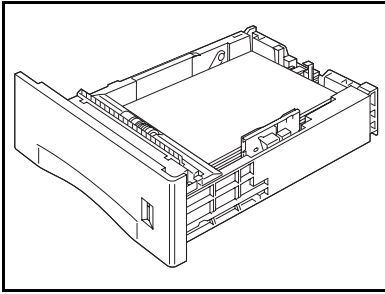

- 9** Load paper into the feeders' trays (refer to Chapter 2 of the *User Guide* for details, if necessary).

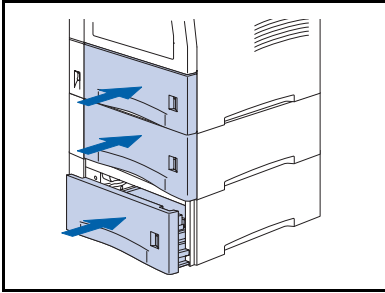

- 10** Insert the standard and optional trays into the computer, making sure they are properly seated.
- 11** Reconnect the printer's power cord and power on the printer.
- 12** Check the Control Panel display. Wait until **Ready** is displayed. If an error message appears, refer to Table 5.1 on page 5-4 for instructions.
- 13** If you have no other options to install, print a Configuration Sheet (see page 1-103) and check it to confirm that the option(s) have been properly installed.

Removing a Feeder

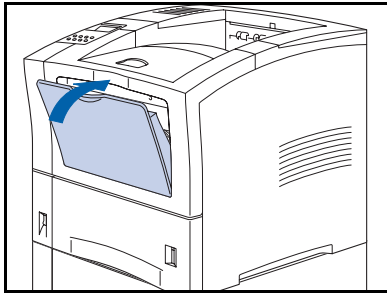

1 If the multi bypass feeder is open, close it.

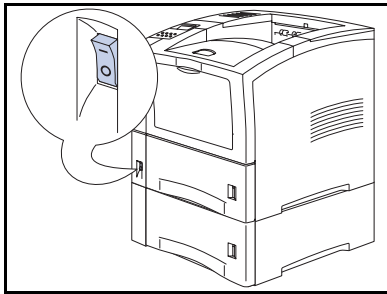

2 Power off the printer.

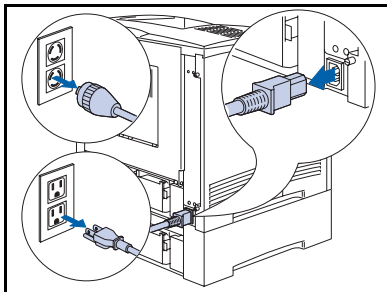

3 Disconnect the power cord from the power outlet and the printer.

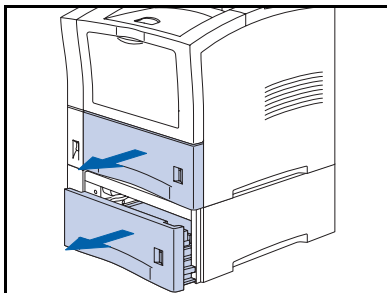

4 Lift up and out to remove the trays from the printer and from the optional feeder.

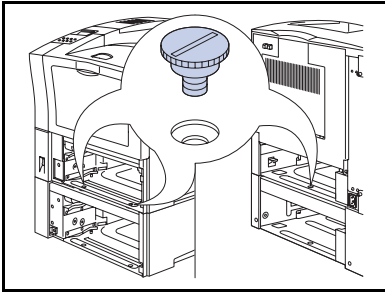

- 5 Remove the three screws that secure the printer to the optional feeder (two in front, one in back).

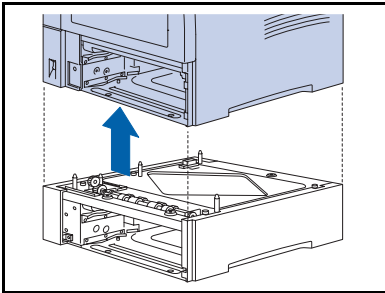

- 6 *Using two people*, lift the printer off of the optional feeder and place it where it will be used.
- 7 Replace the printer's paper trays, reconnect the power cord, and power on the printer.
- 8 Check the Control Panel display. Wait until **Ready** is displayed. If an error message appears, refer to Table 5.1 on page 5-4 for instructions.

Envelope Feeder

Installing

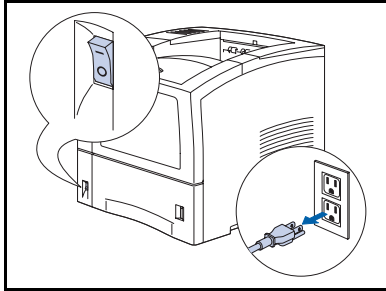

- 1 Power off the printer and disconnect the power cord from the power outlet and the printer.

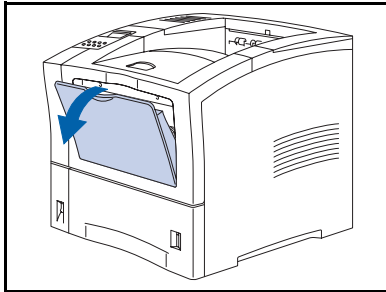

- 2 If the multi bypass feeder is not open, open it.

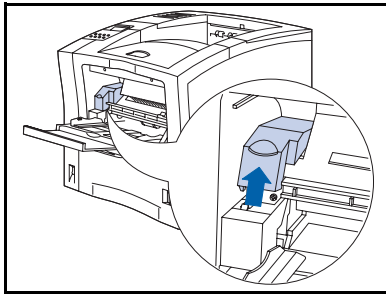

- 3 Remove the access cover.

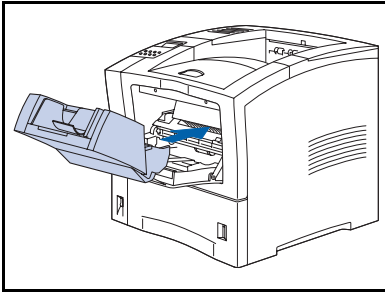

- 4 Push the envelope feeder all the way into the printer until it stops. Make sure it is seated securely.
- 5 Reconnect the printer's power cord and power on the printer.
- 6 Check the Control Panel display. Wait until **Ready** is displayed. If an error message appears, refer to Table 5.1 on page 5-4 for instructions.
- 7 If you have no other options to install, print a Configuration Sheet (see page 1-103) and check it to confirm that the option(s) have been properly installed.

Removing

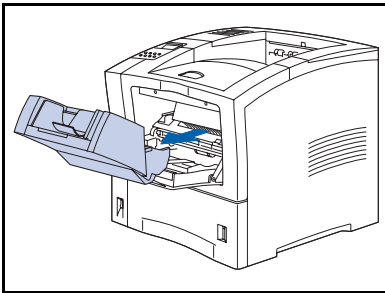
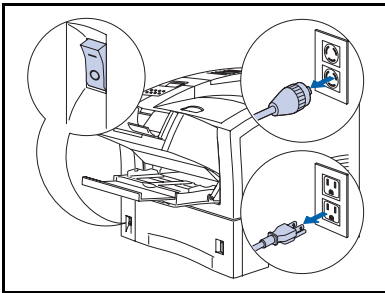

- 1 Power off the printer and disconnect the power cord from the power outlet and the printer.
- 2 Lift slightly on the envelope feeder and pull it out from the printer.
- 3 Reconnect the printer's power cord and power on the printer.
- 4 Check the Control Panel display. Wait until **Ready** is displayed. If an error message appears, refer to Table 5.1 on page 5-4 for instructions.

Offset Catch Tray

Installing



To avoid electric shock, be sure to power off and unplug the printer before accessing its interior for this procedure.

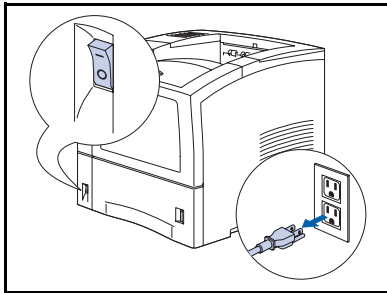

- 1 Power off the printer and disconnect the power cord from the power outlet and the printer.



Installing the Offset Catch Tray while the printer is powered on may cause a malfunction.

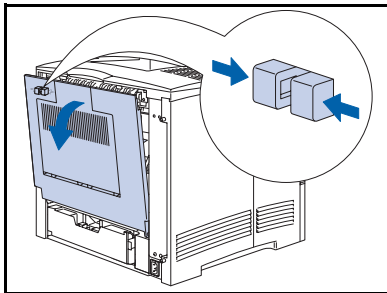

- 2 Open the rear cover.



Be careful not to touch the fuser. It becomes very hot from printing.

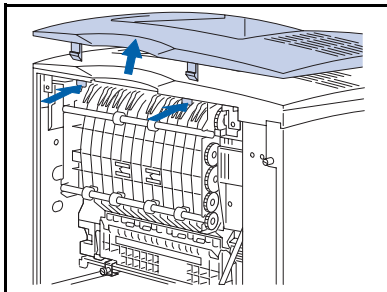

- 3 Push the option cover locking tabs inward and lift off the cover.



Be sure to save the option cover in case you ever remove the Offset Catch Tray.

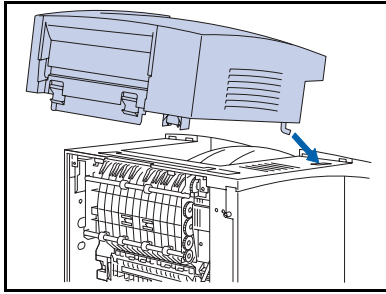

- 4** *Gently* lower the Offset Catch Tray onto the printer, inserting the metal hook at the front of the Offset Catch Tray into the hole on top of the printer.

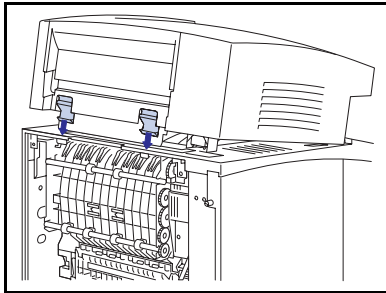

- 5** Continue to lower the Offset Catch Tray until it latches into place.

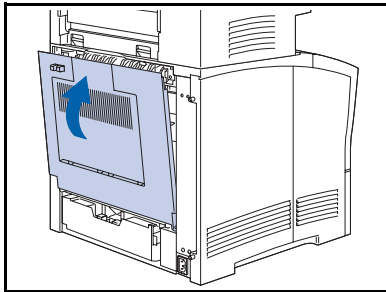

- 6** Close the printer's rear cover.

- 7** Reconnect the printer's power cord and power on the printer.

- 8** Check the Control Panel display. Wait until **Ready** is displayed. If an error message appears, refer to Table 5.1 on page 5-4 for instructions.

- 9** If you have no other options to install, print a Configuration Sheet (see page 1-103) and check it to confirm that the option(s) have been properly installed.

Removing



To avoid electric shock, be sure to power off and unplug the printer before accessing its interior for this procedure.

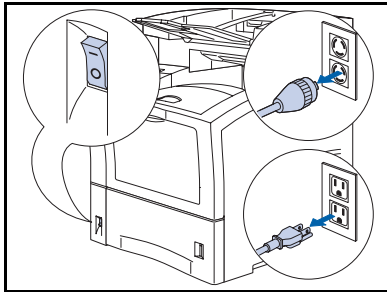

- 1 Power off the printer and disconnect the power cord from the power outlet and the printer.

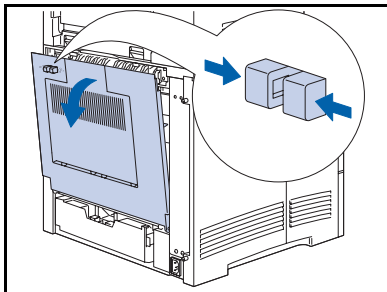

- 2 Open the printer's rear cover.



Be careful not to touch the fuser. It becomes very hot from printing.

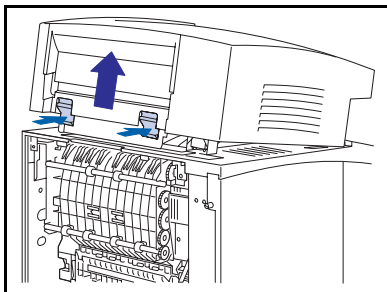

- 3 Push in on the two latches and lift up on the Offset Catch Tray to remove it from the printer.

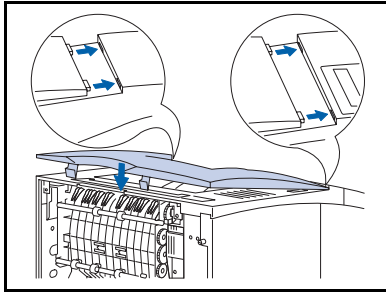

4 Reinstall the option cover into the printer.

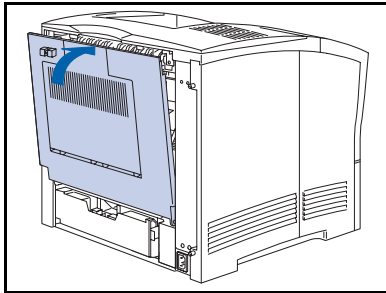

5 Close the printer's rear cover.

6 Reconnect the printer's power cord and power on the printer.

7 Check the Control Panel display. Wait until **Ready** is displayed. If an error message appears, refer to Table 5.1 on page 5-4 for instructions.

Face Up Bin

Installing

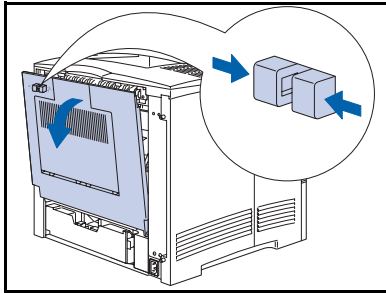

1 Open the printer's rear cover.



Be careful not to touch the fuser. It becomes very hot from printing.

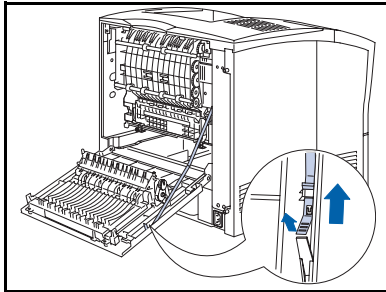

2 Unhook the plastic retaining strip.

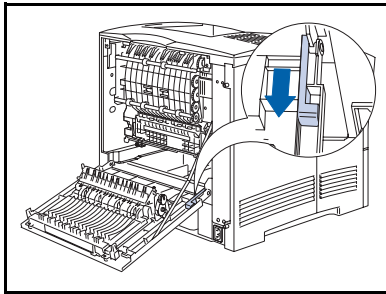

3 Slide the locking clip back.

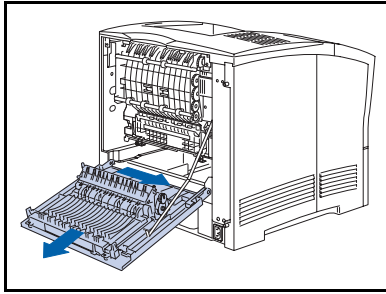

4 Slide the cover to the right and pull it off the pegs.

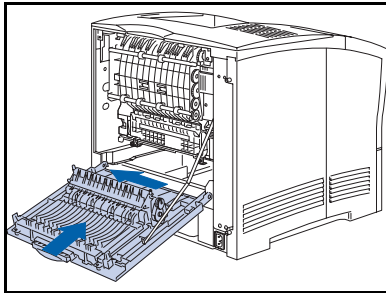

5 Align the rear cover with the face up bin onto the pegs, then slide the cover to the left.

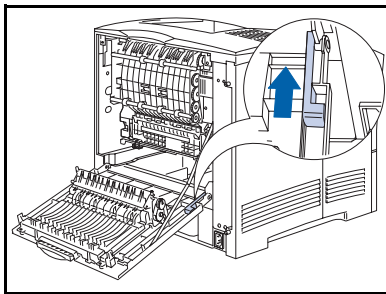

6 Slide the locking clip forward.

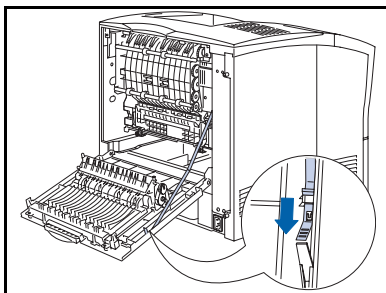

7 Attach the plastic retaining strip.

Face Up Bin

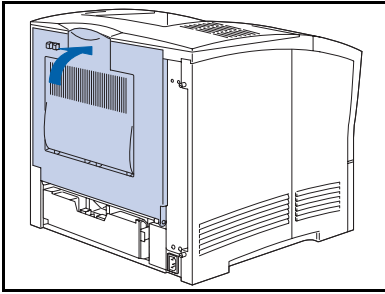

8 Close the rear cover.

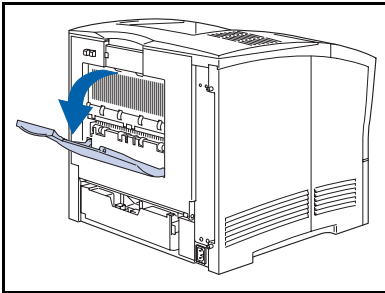

9 Open the face up bin to direct output there.



When the face up bin is open, all output will be delivered there, and all jobs will be printed simplex (1-sided).

Removing

To remove the face up bin, follow the installation instructions starting on page 6-22 but install the printer's original rear cover in place of the cover with the face up bin.

Duplex Module

Installing



To avoid electric shock, be sure to power off and unplug the printer before accessing its interior for this procedure.

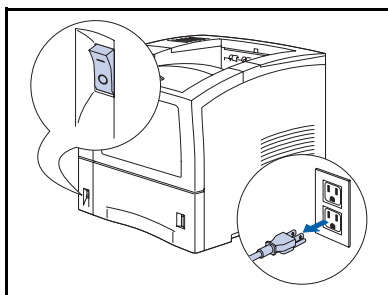

- 1 Power off the printer and disconnect the power cord from the power outlet and the printer.



Installing the duplex unit while the printer is powered on may cause a malfunction.

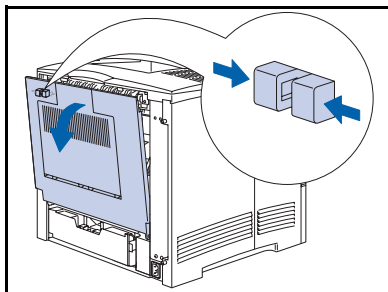

- 2 Open the rear cover.



Be careful not to touch the fuser. It becomes very hot from printing.

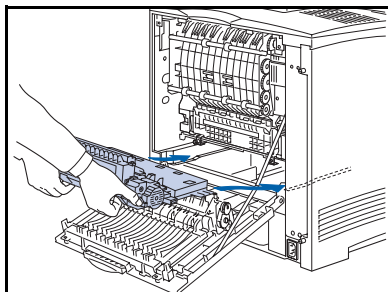

- 3 Remove the packing tape from the duplex module and insert it into the left and right channels inside the printer.

Duplex Module

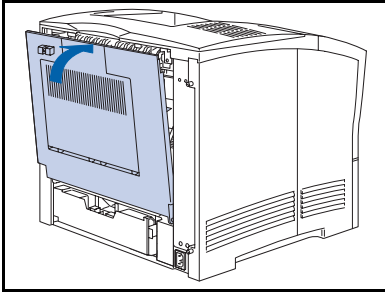
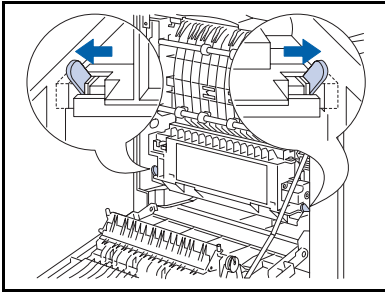

- 4** Slide the unit in until the green levers snap into place.
- 5** Close the printer's rear cover.
- 6** Reconnect the printer's power cord and power on the printer.
- 7** Check the Control Panel display. Wait until **Ready** is displayed. If an error message appears, refer to Table 5.1 on page 5-4 for instructions.
- 8** If you have no other options to install, print a Configuration Sheet (see page 1-103) and check it to confirm that the option(s) have been properly installed.

Removing



To avoid electric shock, be sure to power off and unplug the printer before accessing its interior for this procedure.

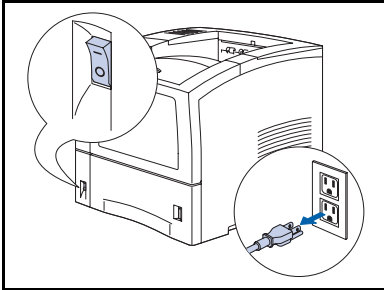

- 1 Power off the printer and disconnect the power cord from the power outlet and the printer.



Removing the duplex unit while the printer is powered on may cause a malfunction.

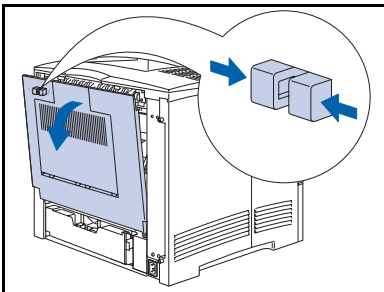

- 2 Open the printer's rear cover.



Be careful not to touch the fuser. It becomes very hot from printing.

Duplex Module

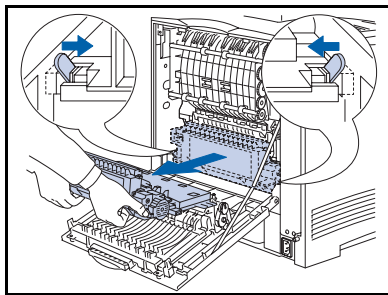

- 3 Slide the green tabs to the left and right of the duplex module inwards and pull the duplex module out of the printer.

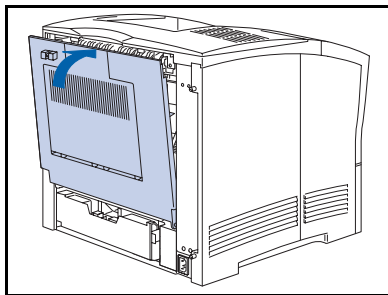

- 4 Close the printer's rear cover.
- 5 Reconnect the printer's power cord and power on the printer.
- 6 Check the Control Panel display. Wait until **Ready** is displayed. If an error message appears, refer to Table 5.1 on page 5-4 for instructions.

Hard Disk Drive

Installing

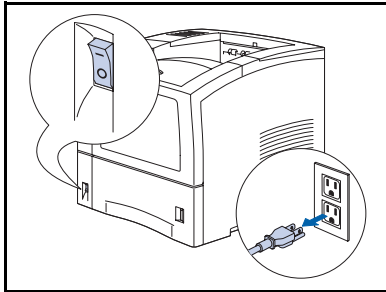

- 1 Power off the printer and disconnect the power cord from the power outlet and the printer.



Installing the hard drive while the printer is powered on may cause a malfunction.

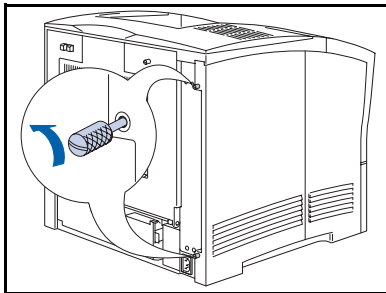

- 2 Go behind the printer and loosen the knurled screws at the top and bottom of the left side cover.

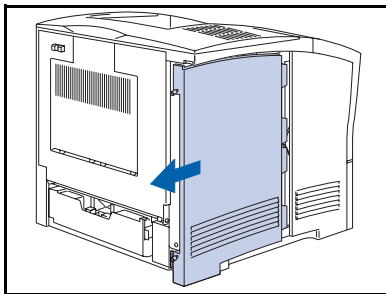

- 3 Slide the left side cover towards you and then down to remove it.

Hard Disk Drive

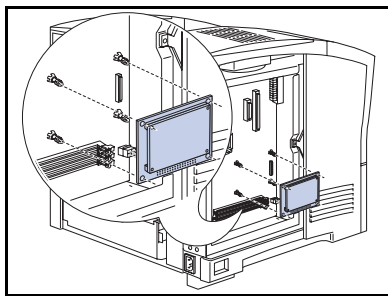

- 4 Align the hard disk drive with the controller board's support posts and connector.



Extra support posts may be delivered with this kit. They are not required for this printer.

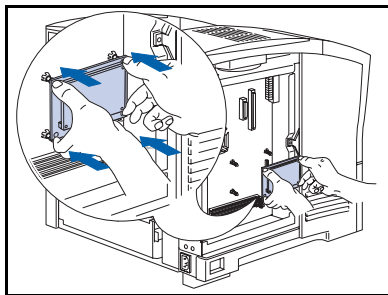

- 5 Push on the hard disk drive until the connector and support posts snap into place.

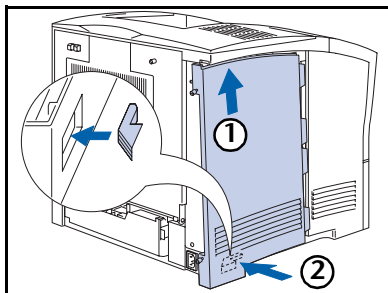

- 6 Replace the side cover by (1) inserting it at an angle and (2) lining up the tab with the printer.

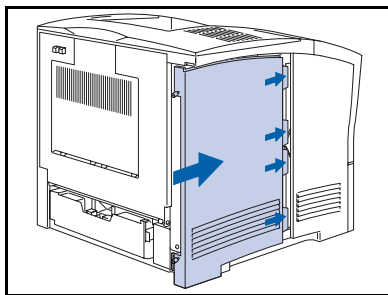

- 7 Slide the side cover into place. Make sure it fits securely.

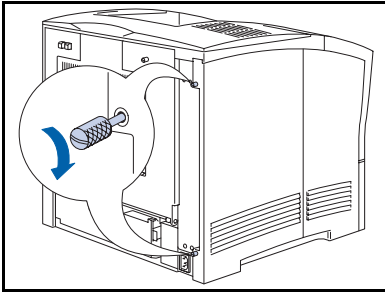

- 8** Tighten the knurled screws at the top and bottom of the side cover.
- 9** Reconnect the printer's power cord and power on the printer.
- 10** Check the Control Panel display. When the printer has completed its power on diagnostics, the display should show **Ready**. If an error message is displayed, refer to Table 5.1 on page 5-5 for instructions.
- 11** If you have no other options to install, print a Configuration Sheet (see page 1-103) and check it to confirm that the option(s) have been properly installed.

Removing

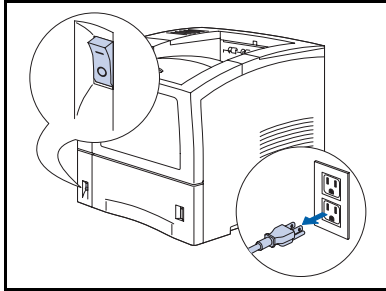

- 1 Power off the printer and disconnect the power cord from the power outlet and the printer.



Removing the hard drive while the printer is powered on may cause a malfunction.

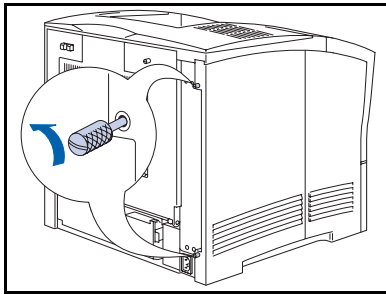

- 2 Go behind the printer and loosen the knurled screws at the top and bottom of the left side cover.

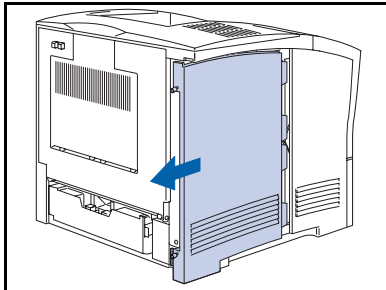

- 3 Slide the left side cover towards you and then down to remove it.

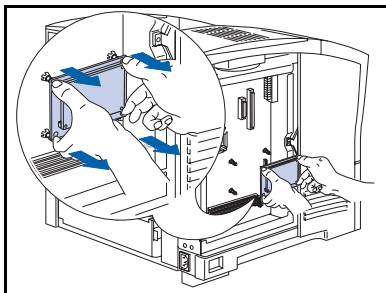

- 4 Gently unclutch the drive from its support posts, and lift it from the controller board.

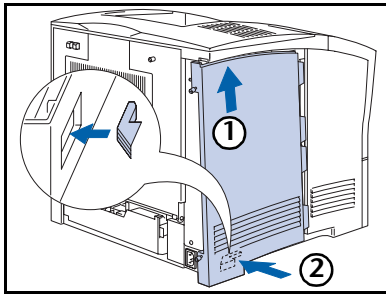

- 5 Replace the side cover by (1) inserting it at an angle and (2) lining up the tab with the printer.

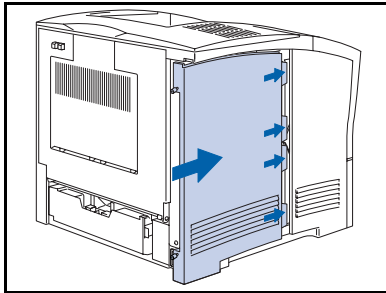

- 6 Slide the side cover into place. Make sure it fits securely.

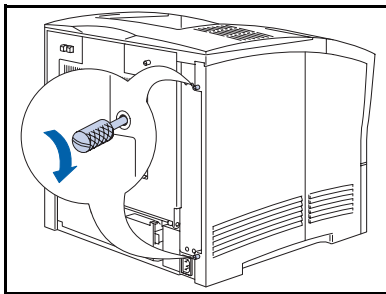

- 7 Tighten the knurled screws at the top and bottom of the side cover.
- 8 Reconnect the printer's power cord and power on the printer.
- 9 Check the Control Panel display. When the printer has completed its power on diagnostics, the display should show **Ready**. If an error message is displayed, refer to Table 5.1 on page 5-5 for instructions.

Interface Card

Installing

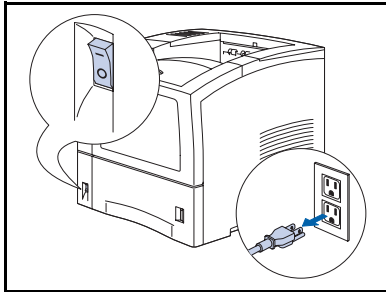

- 1 Power off the printer and disconnect the power cord from the power outlet and the printer.



Installing the card while the printer is powered on may cause a malfunction.

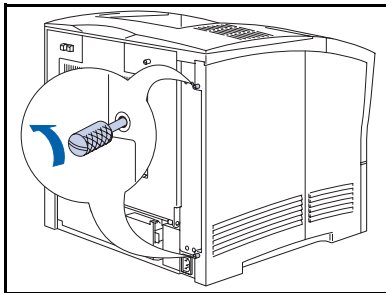

- 2 Go behind the printer and loosen the knurled screws at the top and bottom of the left side cover.

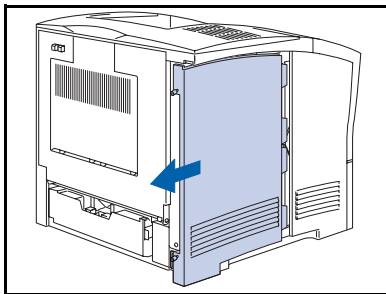

- 3 Slide the left side cover towards you and then down to remove it.

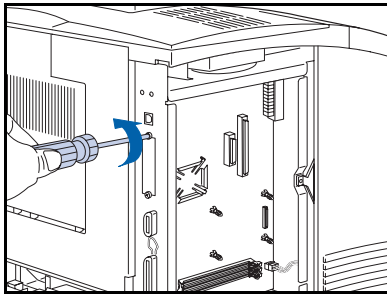

- 4** Remove the port cover plate. Keep the screws and plate.

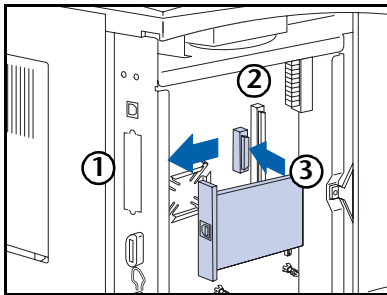

- 5** Install the card by (1) aligning the card's front edge with the port slot, (2) aligning the card's pin connector with the receptacle in the controller board, and (3) pressing the card into the receptacle.

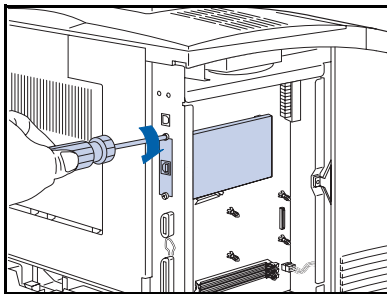

- 6** Secure the card with the screws from Step 4.

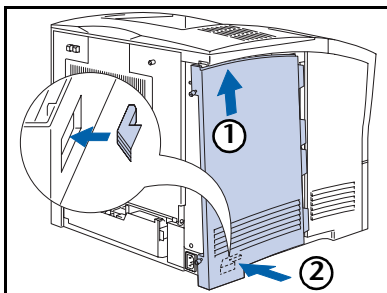

- 7** Replace the side cover by (1) inserting it at an angle and (2) lining up the tab with the printer.

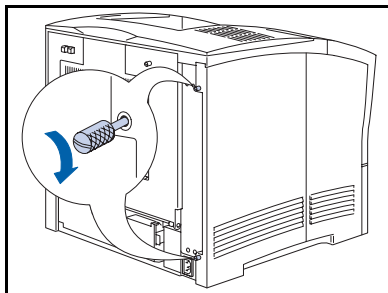
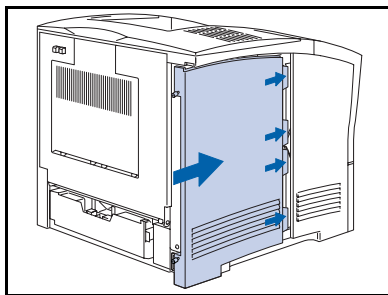

8 Slide the side cover into place. Make sure it fits securely.

9 Tighten the knurled screws at the top and bottom of the side cover.

10 Reconnect the printer's power cord and power on the printer.

11 Check the Control Panel display. When the printer has completed its power on diagnostics, the display should show **Ready**. If an error message is displayed, refer to Table 5.1 on page 5-5 for instructions.

12 If you have no other options to install, print a Configuration Sheet (see page 1-103) and check it to confirm that the option(s) have been properly installed.

Removing

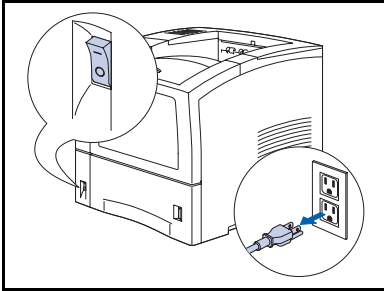

- 1 Power off the printer and disconnect the power cord from the power outlet and the printer.



Installing the hard drive while the printer is powered on may cause a malfunction.

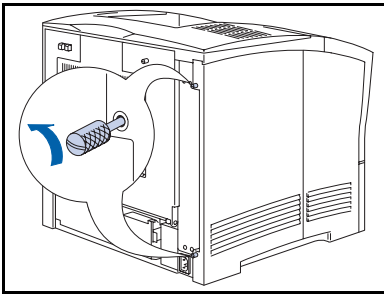

- 2 Go behind the printer and loosen the knurled screws at the top and bottom of the left side cover.

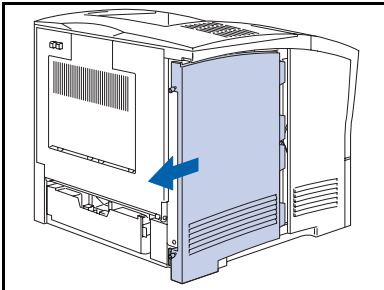

- 3 Slide the left side cover towards you and then down to remove it.

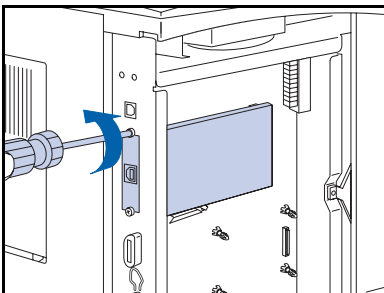

- 4 Remove the screws that secure the card to the controller board. Keep the screws.

Interface Card

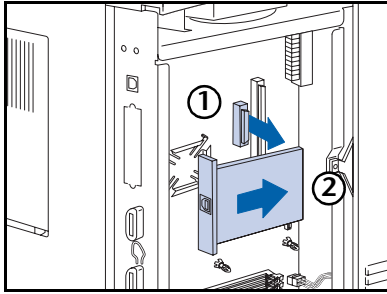

- 5 Remove the card by pulling the card (1) up from the controller board's receptacle, then (2) away from the port slot.

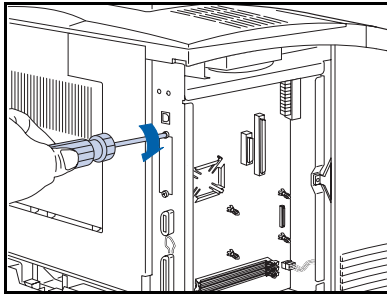

- 6 Secure the original port cover plate with the screws from Step 4.

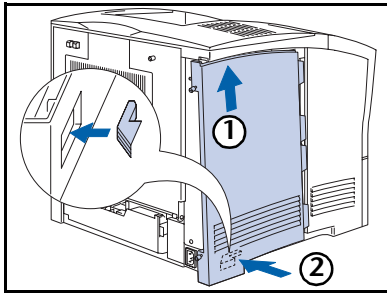

- 7 Replace the side cover by (1) inserting it at an angle and (2) lining up the tab with the printer.

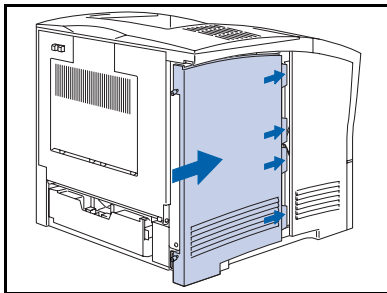

- 8 Slide the side cover into place. Make sure it fits securely.

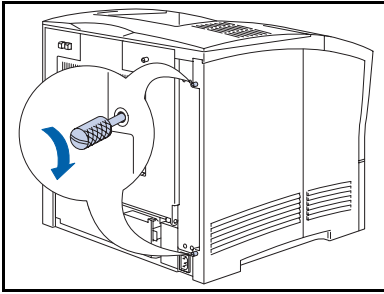

- 9 Tighten the knurled screws at the top and bottom of the side cover.
- 10 Reconnect the printer's power cord and power on the printer.
- 11 Check the Control Panel display. When the printer has completed its power on diagnostics, the display should show **Ready**. If an error message is displayed, refer to Table 5.1 on page 5-5 for instructions.
- 12 If you have no other options to install, print a Configuration Sheet (see page 1-103) and check it to confirm that the option(s) have been properly installed.

Additional Memory

Installing or Removing

The following procedure is used for installing both system memory and flash memory.

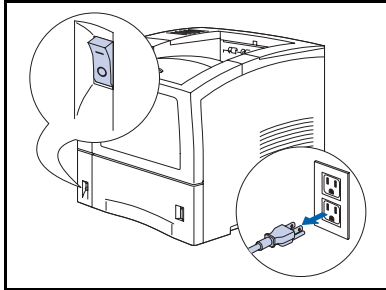

- 1 Power off the printer and disconnect the power cord from the power outlet and the printer.

 **Installing memory while the printer is powered on may cause a malfunction.**

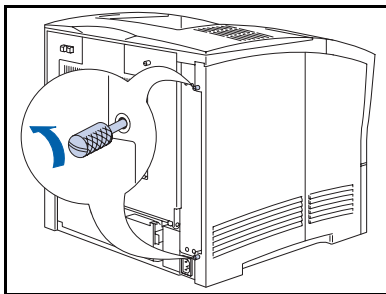

- 2 Go behind the printer and loosen the knurled screws at the top and bottom of the left side cover.

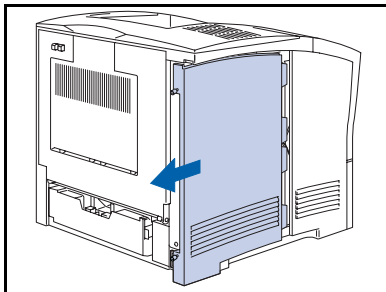

- 3 Slide the left side cover towards you and then down to remove it.

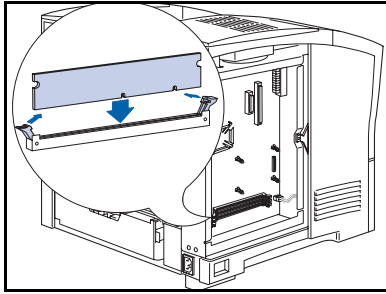

- 4** Insert the memory into an available slot and gently push it in until the edge clips lock into place. If the clips do not engage, manually close them on the memory.

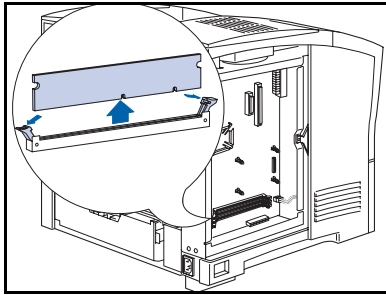

To remove the memory, release the edge clips and gently pull the memory out of the slot.

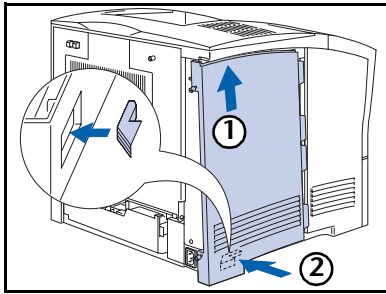

- 5** Replace the side cover by (1) inserting it at an angle and (2) lining up the tab with the printer.

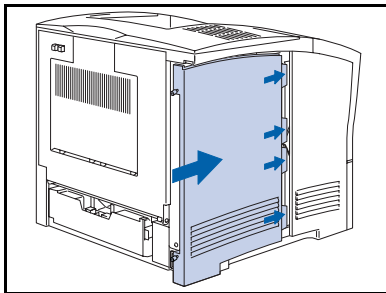

- 6** Slide the side cover into place. Make sure it fits securely.

Additional Memory

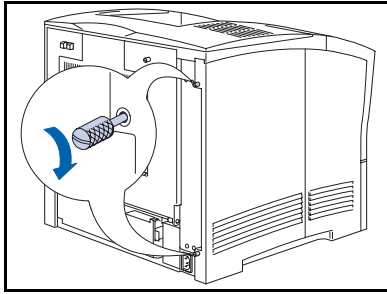

- 7 Tighten the knurled screws at the top and bottom of the side cover.
- 8 Reconnect the printer's power cord and power on the printer.
- 9 Check the Control Panel display. When the printer has completed its power on diagnostics, the display should show **Ready**. If an error message is displayed, refer to Table 5.1 on page 5-5 for instructions.
- 10 If you have no other options to install, print a Configuration Sheet (see page 1-103) and check it to confirm that the option(s) have been properly installed.

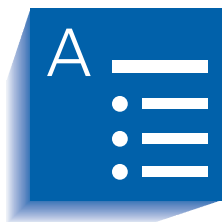

Index

A

- AppSocket Binary PS
 - Setting
 - In Ethernet
 - Menu • 1-73
 - In Token Ring
 - Menu • 1-87
- AppSocket Enable
 - Setting
 - In Ethernet
 - Menu • 1-72
 - In Token Ring
 - Menu • 1-86
- AppSocket PDL
 - Setting
 - In Ethernet
 - Menu • 1-72
 - In Token Ring
 - Menu • 1-86

B

- Baud Rate
 - Setting • 1-61
- Bias transfer roller
 - Replacing • 4-11 → 4-13
- Bidirectional
 - Setting • 1-57

Binary PS

- Setting • 1-56, 1-61, 1-64

C

- Cancel Job
 - Performing • 1-17
- CentreWare DP
 - Description • 2-2
 - Features • 2-2
 - Usage
 - Initializing the Hard Disk Drive • 3-2
 - Offsetting output • 1-125
- CentreWare Internet Services • 2-4
- Cleaning the printer • 4-2
- Config Fuser
 - Setting • 1-29
- Configuration Sheet
 - Printing • 1-104
- Control Panel
 - Display • 1-4
 - Indicator lights • 1-5
 - Keys • 1-6 → 1-7
 - Messages • 5-4 → 5-11
 - Using • 1-3 → 1-7

D

Custom Paper Sizes • 1-130 → 1-134
 Configuring • 1-130
 Examples • 1-134

Custom Size
 Setting • 1-28

D

Default Gateway
 Setting
 In Ethernet Menu • 1-77
 In Token Ring Menu • 1-91

Defaults
 Setting • 1-53

Delete All Jobs
 Performing • 1-112

Demo Mode
 Setting • 1-111

Disk Directory
 Printing • 1-106

Disk Format
 Performing • 1-113

Disk Initialize
 Performing • 1-112

Display Faults • 1-107

DLC/LLC Binary PS
 Setting
 In Ethernet Menu • 1-70
 In Token Ring Menu • 1-84

DLC/LLC Enable
 Setting
 In Ethernet Menu • 1-69
 In Token Ring Menu • 1-83

DLC/LLC PDL
 Setting
 In Ethernet Menu • 1-69
 In Token Ring Menu • 1-83

Downloading
 Fonts • 3-3 → 3-7
 Forms • 3-3 → 3-7
 Macros • 3-3 → 3-7

Draft Mode
 Setting • 1-48

Drivers
 Usage

Downloading fonts • 3-3
Downloading forms • 3-3
Downloading macros • 3-3

Duplex
 Setting • 1-48

Duplex Module
 Installing • 6-25 → 6-26
 Removing • 6-27 → 6-28

Duplex Printing • 1-128 → 1-129

E

Edge-to-Edge
 Setting • 1-49

Envelope Feeder
 Installing • 6-16 → 6-17
 Removing • 6-17

Envelope Size
 Setting • 1-25

Envelope Type
 Setting • 1-26

ETalk Enable
 Setting • 1-73

Ethernet Menu • 1-65 → 1-66
 Items

 AppSocket Bin PS • 1-73
 AppSocket Enable • 1-72
 AppSocket PDL • 1-72
 Default Gateway • 1-77
 DLC/LLC Bin PS • 1-70
 DLC/LLC Enable • 1-69
 DLC/LLC PDL • 1-69
 ETalk Enable • 1-73
 HTTP Enable • 1-74
 IP Address • 1-75
 IP Address Reset • 1-74
 LPR Banner • 1-67
 LPR Binary PS • 1-68
 LPR Enable • 1-67
 LPR PDL • 1-68
 NetBEUI Bin PS • 1-71
 NetBEUI Enable • 1-70
 NetBEUI PDL • 1-71
 Port Timeout • 1-78
 Speed • 1-78
 Sub Net Mask • 1-76

Ethernet 10Base2 Card
 Description • 6-4

F

Face Up Bin

- Installing • 6-22 → 6-24
- Removing • 6-24

Factory Defaults

- Resetting to • 1-110

Fault History

- Printing • 1-107

Feed rollers

- Replacing • 4-7 → 4-10

Flash Format

- Performing • 1-113

Flash Memory

- Description • 3-2
- Initializing • 3-2
- Usage
 - Downloading fonts • 3-3
 - Downloading forms • 3-3
 - Downloading macros • 3-3

Flow Control

- Setting • 1-60

Font Number

- Setting • 1-36

Fonts

- Downloading • 3-3 → 3-7

Form Feed

- Forcing • 1-17

Form Length

- Setting • 1-40

Forms

- Downloading • 3-3 → 3-7

Frame Type

- Setting • 1-98

Fuser

- Replacing • 4-14 → 4-16

H

Hard Disk Drive

- Control Panel settings • 1-112
- Description • 3-2
- Initializing • 3-2
- Installing • 6-29 → 6-31
- Removing • 6-32 → 6-33
- Usage

- Downloading fonts • 3-3
- Downloading forms • 3-3
- Downloading macros • 3-3
- Printing secure jobs and proof jobs • 3-8 → 3-12

Hex Mode

- Setting • 1-108

HTTP Enable

- Setting
 - In Ethernet Menu • 1-74
 - In Token Ring Menu • 1-88

I

Internet

- Also see CentreWare Internet Services

IP Address

- Setting
 - In Ethernet Menu • 1-75
 - In Token Ring Menu • 1-89

IP Address Reset

- Setting
 - In Ethernet Menu • 1-74
 - In Token Ring Menu • 1-88

J

Job Menu • 1-16

- Items
 - Cancel Job • 1-17
 - Form Feed • 1-17
 - Restart Printer • 1-18

L

LAA

- Setting • 1-94

Language

- Setting • 1-44

Laser print cartridge

- Replacing • 4-3 → 4-5

Line Termination

- Setting • 1-41

LPR Banner

- Setting
 - In Ethernet Menu • 1-67
 - In Token Ring Menu • 1-81

M

- LPR Binary PS
 - Setting
 - In Ethernet Menu • 1-68
 - In Token Ring Menu • 1-82
 - LPR Enable
 - Setting
 - In Ethernet Menu • 1-67
 - In Token Ring Menu • 1-81
 - LPR PDL
 - Setting
 - In Ethernet Menu • 1-68
 - In Token Ring Menu • 1-82
- ## M
- Macros
 - Downloading • 3-3 → 3-7
 - Mail Send/Receive • 2-5
 - MaiLinx Mail Receive • 2-5
 - MaiLinx Mail Send • 2-5
 - Maintenance kit
 - Description • 4-6
 - Installation • 4-6
 - MBF Size
 - Setting • 1-24
 - MBF Type
 - Setting • 1-25
 - Memory
 - Installing or removing • 6-40 → 6-42
 - Menu Map
 - Printing • 1-106

N

- NDS Context
 - Setting • 1-102
- NDS Tree
 - Setting • 1-101
- NetBEUI Binary PS
 - Setting
 - In Ethernet Menu • 1-71
 - In Token Ring Menu • 1-85
- NetBEUI Enable
 - Setting
 - In Ethernet Menu • 1-70
 - In Token Ring Menu • 1-84

- NetBEUI PDL
 - Setting
 - In Ethernet Menu • 1-71
 - In Token Ring Menu • 1-85
- Network Defaults
 - Resetting to • 1-110
- Network Interface Card
 - Installing • 6-34 → 6-36
 - Removing • 6-37 → 6-39
- Novell Binary PS
 - Setting
 - In Novell Menu • 1-97
- Novell Enable
 - Setting • 1-96
- Novell Menu • 1-95
 - Items
 - Frame Type • 1-98
 - NDS Context • 1-102
 - NDS Tree • 1-101
 - Novell Binary PS • 1-97
 - Novell Enable • 1-96
 - Novell Mode • 1-97
 - Novell PDL • 1-96
 - Polling Interval • 1-98
 - Primary Server • 1-100
 - PServer Name • 1-99
- Novell Mode
 - Setting • 1-97
- Novell PDL
 - Setting • 1-96

O

- Offset Catch Tray
 - Installing • 6-18 → 6-19
 - Removing • 6-20 → 6-21
- Offsetting output • 1-125 → 1-127
- Orientation
 - Setting • 1-39
- Output Destination
 - Setting • 1-51
- Output Offset
 - Setting • 1-51
- Output Timeout
 - Setting • 1-50

P

- Page Policy
 - Setting • 1-46
- Paper
 - Offsetting output • 1-125
 - Specifying size of • 1-45
 - Specifying type of • 1-45
- Paper Size
 - Setting • 1-45
- Paper Type
 - Setting • 1-45
- Parallel Menu • 1-54
 - Items
 - Bidirectional • 1-57
 - Binary PS • 1-56
 - Parallel PDL • 1-56
 - Port Enable • 1-55
 - Port Timeout • 1-55
- Parallel PDL
 - Setting • 1-56
- Password Menu • 1-19
 - Usage • 1-19 → 1-21
- PCL Demo Page
 - Printing • 1-104
- PCL Font List
 - Printing • 1-105
- PCL Menu • 1-35
 - Items
 - Font Number • 1-36
 - Form Length • 1-40
 - Line Termination • 1-41
 - Orientation • 1-39
 - Pitch • 1-36
 - Point Size • 1-37
 - Symbol Set • 1-38
- Pitch
 - Setting • 1-36
- Point Size
 - Setting • 1-37
- Policy Timeout
 - Setting • 1-47
- Polling Interval
 - Setting • 1-98
- Port Enable
 - Setting
 - In Parallel Menu • 1-55
 - In Serial Menu • 1-59
 - In USB Menu • 1-63
- Port Timeout
 - Setting
 - In Ethernet Menu • 1-78
 - In Parallel Menu • 1-55
 - In Serial Menu • 1-59
 - In Token Ring Menu • 1-92
 - In USB Menu • 1-63
- PostScript
 - Enabling binary mode • 1-56
 - Font List • 1-105
 - Printing errors • 1-52
 - Setting AppSocket binary mode • 1-73, 1-87
 - Setting binary mode • 1-61, 1-64
 - Setting DLC/LLC binary mode • 1-70, 1-84
 - Setting LPR binary mode • 1-68, 1-82
 - Setting NetBEUI binary mode • 1-71, 1-85
 - Setting Novell binary mode • 1-97
- Power Saver
 - Setting • 1-52
- Primary Server
 - Setting • 1-100
- Print Menu • 1-103
 - Items
 - Configuration Sheet • 1-104
 - Disk Directory • 1-106
 - Display Faults • 1-107
 - Fault History • 1-107
 - Hex Mode • 1-108
 - Menu Map • 1-106
 - PCL Demo • 1-104
 - PCL Font List • 1-105
 - PS Font List • 1-105
 - Restart Printer • 1-108
 - Test Print • 1-106
- Print PS Errors
 - Setting • 1-52
- Print Quantity
 - Setting • 1-47
- Printer cleaning • 4-2
- Proof jobs
 - Creating • 3-10 → 3-11

R

PS Font List
Printing • 1-105

PServer Name
Setting • 1-99

R

Reset Menu • 1-109
Items

- Delete All Jobs • 1-112
- Demo Mode • 1-111
- Disk Format • 1-113
- Disk Initialize • 1-112
- Factory Defaults • 1-110
- Flash Format • 1-113
- Network Defaults • 1-110

Resolution
Setting • 1-50

Restart Printer
Initiating • 1-18
Performing • 1-108

S

Secure jobs
Creating • 3-8 → 3-9

Serial Menu • 1-58
Items

- Baud Rate • 1-61
- Binary PS • 1-61
- Flow Control • 1-60
- Port Enable • 1-59
- Port Timeout • 1-59
- Serial PDL • 1-60

Serial PDL
Setting • 1-60

Source Routing
Setting • 1-93

Speed
Setting
In Ethernet Menu • 1-78
In Token Ring Menu • 1-93

Standard Bin
Setting as output destination • 1-51

Sub Net Mask
Setting
In Ethernet Menu • 1-76
In Token Ring Menu • 1-90

Symbol Set
Setting • 1-38

System Menu • 1-42 → 1-43
Items

- Defaults • 1-53
- Draft Mode • 1-48
- Duplex • 1-48
- Edge-to-Edge • 1-49
- Language • 1-44
- Output Destination • 1-51
- Output Offset • 1-51
- Output Timeout • 1-50
- Page Policy • 1-46
- Paper Size • 1-45
- Paper Type • 1-45
- Policy Timeout • 1-47
- Power Saver • 1-52
- Print PS Errors • 1-52
- Print Quantity • 1-47
- Resolution • 1-50
- XIE • 1-49

T

Test Print
Printing • 1-106

Token Ring Card
Description • 6-4

Token Ring Menu • 1-79 → 1-80
Items

- AppSocket Binary PS • 1-87
- AppSocket Enable • 1-86
- AppSocket PDL • 1-86
- Default Gateway • 1-91
- DLC/LLC Binary PS • 1-84
- DLC/LLC Enable • 1-83
- DLC/LLC PDL • 1-83
- HTTP Enable • 1-88
- IP Address • 1-89
- IP Address Reset • 1-88
- LAA • 1-94
- LPR Banner • 1-81
- LPR Binary PS • 1-82
- LPR Enable • 1-81
- LPR PDL • 1-82
- NetBEUI Bin PS • 1-85
- NetBEUI Enable • 1-84
- NetBEUI PDL • 1-85
- Port Timeout • 1-92
- Source Routing • 1-93
- Speed • 1-93

Sub Net Mask • 1-90
 TTalk Enable • 1-87

Toner

Reducing usage of • 1-48

Tray Menu • 1-22 → 1-23

Items

Config Fuser • 1-29
 Custom Size • 1-28
 Envelope Size • 1-25
 Envelope Type • 1-26
 MBF Size • 1-24
 MBF Type • 1-25
 Tray Sequence • 1-27
 Tray 1 Mode • 1-28
 Tray 1 Type • 1-26
 Tray 2 Mode • 1-28
 Tray 2 Type • 1-26
 Tray 3 Mode • 1-28
 Tray 3 Type • 1-26

Tray Sequence

Also see Tray switching

Setting • 1-27

Usage examples • 1-122

Usage rules • 1-120

Tray switching

Also see Tray Sequence

Description • 1-114 → 1-124

Examples • 1-122

Paper handling exception
 conditions • 1-117 → 1-119

Paper size/type mismatch • 1-124

Rules • 1-120

Tray Sequence settings • 1-116

Tray 1 Mode

Setting • 1-28

Tray 1 Type

Setting • 1-26

Tray 2 Mode

Setting • 1-28

Tray 2 Type

Setting • 1-26

Tray 3 Mode

Setting • 1-28

Tray 3 Type

Setting • 1-26

Troubleshooting

Control Panel messages • 5-4 → 5-11

TTalk Enable

Setting • 1-87

U

USB Menu • 1-62

Items

Binary PS • 1-64

Port Enable • 1-63

Port Timeout • 1-63

USB PDL • 1-64

USB PDL

Setting • 1-64

X

XIE

Setting • 1-49

Numerics

550 Sheet Feeder

Installing • 6-6 → 6-13

Removing • 6-14 → 6-15

